



NEWS 2025

**0% Rabatt
Discount**

ULTRA PRÄZISION MESSZEUGE GMBH



TRADITION • PRÄZISION • INNOVATION seit 1888
TRADITION • PRECISION • INNOVATION since 1888



Prüfstiftsätze Spezialstahl gehärtet



- ▶ DIN 2269
- ▶ Härte 60 ±2 HRC
- ▶ > Ø 1,50mm mit Fase
- ▶ ab Ø 2,00mm mit Nennmaß beschriftet
- ▶ Bohrungen im Etui mit Nennmaß beschriftet
- ▶ Lieferung im Holzetui

10661.. :

Toleranz ± 0,001mm

10672.. :

Toleranz ± 0,002mm

Pin gauge sets Hardened special steel

- ▶ DIN 2269
- ▶ Hardness 60 ±2 HRC
- ▶ > Ø 1.50mm with chamfer
- ▶ Nominal size marked from Ø 2.00mm
- ▶ Bore nominal sizes marked on the box
- ▶ Delivered in wooden box

10661.. :

Tolerance ± 0.001mm

10672.. :

Tolerance ± 0.002mm

Shop



No. 1066105

Alle Preise abzüglich Rabatt! / Rabatt anfragen
All prices less discount! / Ask for discount

+49 (0) 6021 42999 00

-%

Ø mm	mm	Stück / Pieces	kg	±0,001mm N ^o		±0,002mm N ^o	
Ø 0,30 – 0,50	0,01	21	1,83	1066102	497,00 €	1067202	456,00 €
Ø 0,50 – 1,00	0,01	51	1,83	1066103	671,00 €	1067203	526,00 €
Ø 0,10 – 1,00	0,05	19	1,9	1066104	501,00 €	1067204	442,00 €
Ø 1,00 – 5,00	0,05	81	1,5	1066104x	997,00 €	1067204x	778,00 €
Ø 1,00 – 10,00	0,1	91	4,5	1066105	1.258,00 €	1067205	949,00 €
Ø 1,00 – 5,00	0,1	41	1,97	1066105x	572,00 €	1067205x	449,00 €
Ø 5,05 – 10,00	0,05	100	3,8	1066108	1.717,00 €	1067208	1.342,00 €
Ø 1,00 – 2,00	0,01	101	1,9	1066115	1.065,00 €	1067215	821,00 €
Ø 2,01 – 3,00	0,01	100	2,1	1066116	1.059,00 €	1067216	817,00 €
Ø 3,01 – 4,00	0,01	100	2,3	1066117	1.305,00 €	1067217	1.011,00 €
Ø 4,01 – 5,00	0,01	100	2,6	1066118	1.305,00 €	1067218	1.011,00 €
Ø 5,01 – 6,00	0,01	100	2,9	1066119	1.308,00 €	1067219	1.012,00 €
Ø 6,01 – 7,00	0,01	100	3,8	1066120	1.676,00 €	1067220	1.206,00 €
Ø 7,01 – 8,00	0,01	100	4,3	1066121	1.695,00 €	1067221	1.352,00 €
Ø 8,01 – 9,00	0,01	100	4,9	1066122	1.695,00 €	1067222	1.352,00 €
Ø 9,01 – 10,00	0,01	100	5,8	1066123	1.699,00 €	1067223	1.358,00 €

Prüfen von Bohrungstoleranzen.
Measuring of bore tolerances.

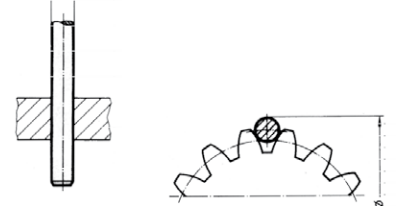

Gewinde- und Verzahnungsmessung.
Thread and spline measuring.

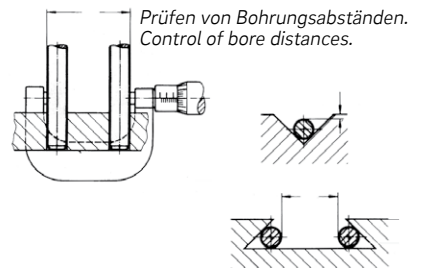

Prüfen von Bohrungsabständen.
Control of bore distances.

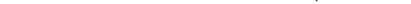

Winkel- und Profilprüfung.
Control of angles and profiles.

NEW

Prüfstifte / Pin gauges

Shop

Jetzt bis Ø 50mm im Shop bestellbar!
Now up to Ø 50mm orderable in our shop!

±0,0005mm / ±0,001mm / ±0,002mm



NEW!

Ø 0,1mm 20,00mm

... Ø 50,00mm

Stahl / steel



rostfreier Stahl / stainless steel



Hartmetall / tungsten carbide



Keramik / ceramic



Prüfstifte einzeln, STANDARDLÄNGEN Spezialstahl gehärtet mit Stufung 0,01mm



- ▶ DIN 2269
- ▶ Härte 60 ±2 HRC
- ▶ > Ø 1,50mm mit Fase
- ▶ ab Ø 2,00mm mit Nennmaß beschriftet
- ▶ Lieferung einzeln verpackt

1068... :

Toleranz ± 0,001mm

1069... :

Toleranz ± 0,002mm

Bestellhinweis: bitte das exakte Nennmaß angeben, z.B. Ø 10,15mm, Ø 30,20mm oder Ø 50,00mm.

Pin gauges singles, STANDARD LENGTHS Hardened special steel with step 0.01mm

- ▶ DIN 2269
- ▶ Hardness 60 ±2 HRC
- ▶ > Ø 1.50mm with chamfer
- ▶ Nominal size marked from Ø 2.00mm
- ▶ Delivered in individual packages

1068... :

Tolerance ± 0.001mm

1069... :

Tolerance ± 0.002mm

Order notice: Please enter the exact nominal size, e.g. Ø 10.15, Ø 30.20mm or Ø 50.00mm..

Spezialstahl, Stufung 0,01mm
Special steel, step 0.01mm



NEW

**JETZT BIS Ø 50,00mm!
NOW UP TO Ø 50.00mm!**



Alle Preise abzüglich Rabatt! / Rabatt anfragen
All prices less discount! / Ask for discount

+49 (0) 6021 42999 00

-%

Ø mm	mm	mm	±0,001mm Nº	mm	±0,002mm Nº	mm	mm
0,10 – 0,14	0,01	40	1068099	40,20 €	40	1069099	36,60 €
0,15 – 0,29	0,01	40	1068100	40,20 €	40	1069100	36,00 €
0,30 – 0,49	0,01	40	1068100x	19,90 €	40	1069100x	18,10 €
0,50 – 0,99	0,01	40	1068101	11,60 €	40	1069101	8,70 €
1,00 – 2,99	0,01	70	1068201	10,00 €	70	1069201	7,20 €
3,00 – 5,99	0,01	70	1068301	13,10 €	70	1069301	9,50 €
6,00 – 9,99	0,01	70	1068401	17,20 €	70	1069401	11,80 €
10,00 – 11,99	0,01	70	1068501	23,50 €	70	1069501	15,80 €
12,00 – 13,99	0,01	70	1068601	26,80 €	70	1069601	18,60 €
14,00 – 15,99	0,01	70	1068701	35,20 €	70	1069701	23,20 €
16,00 – 18,99	0,01	70	1068801	43,30 €	70	1069801	27,30 €
19,00 – 20,00	0,01	70	1068901	51,50 €	70	1069901	31,30 €
20,01 – 21,99	0,01	70	1068902	210,00 €	70	1069902	163,00 €
22,00 – 23,99	0,01	70	1068903	222,00 €	70	1069903	180,00 €
24,00 – 24,99	0,01	70	1068904	228,00 €	70	1069904	195,00 €
25,00 – 26,99	0,01	70	1068905	451,00 €	70	1069905	296,00 €
27,00 – 31,99	0,01	70	1068906	497,00 €	70	1069906	332,00 €
32,00 – 36,99	0,01	70	1068907	572,00 €	70	1069907	356,00 €
37,00 – 39,99	0,01	70	1068908	636,00 €	70	1069908	385,00 €
40,00 – 50,00	0,01	-	-	-	70	1069909	451,00 €

Spezialstahl, Stufung 0,001mm
Special steel, step 0.001mm



NEW

**JETZT BIS Ø 40,00mm!
NOW UP TO Ø 40.00mm!**



Prüfstifte einzeln, STANDARDLÄNGEN Spezialstahl gehärtet mit Stufung 0,001mm



▶ Siehe oben

Pin gauges singles, STANDARD LENGTHS Hardened special steel with step 0.001mm

▶ See above

Alle Preise abzüglich Rabatt! / Rabatt anfragen
All prices less discount! / Ask for discount

+49 (0) 6021 42999 00

-%

Ø mm	mm	mm	±0,001mm Nº	mm	mm	mm	±0,001mm Nº	mm	
0,100 – 0,149	0,001	40	1068099zm	75,00 €	16,000 – 17,999	0,001	70	1068801zm	116,00 €
0,150 – 0,299	0,001	40	1068100zm	52,50 €	18,000 – 20,000	0,001	70	1068901zm	149,00 €
0,300 – 0,499	0,001	40	1068100xzm	36,70 €	20,001 – 21,999	0,001	70	1068902zm	285,00 €
0,500 – 0,999	0,001	40	1068101zm	38,90 €	22,000 – 23,999	0,001	70	1068903zm	313,00 €
1,000 – 4,999	0,001	70	1068201zm	48,20 €	24,000 – 24,999	0,001	70	1068904zm	329,00 €
5,000 – 6,999	0,001	70	1068301zm	53,00 €	25,000 – 26,999	0,001	70	1068905zm	544,00 €
7,000 – 9,999	0,001	70	1068401zm	59,00 €	27,000 – 31,999	0,001	70	1068906zm	582,00 €
10,000 – 11,999	0,001	70	1068501zm	69,00 €	32,000 – 36,999	0,001	70	1068907zm	670,00 €
12,000 – 13,999	0,001	70	1068601zm	84,00 €	37,000 – 40,000	0,001	70	1068908zm	745,00 €
14,000 – 15,999	0,001	70	1068701zm	106,00 €					

Prüfstifte einzeln, SONDERLÄNGEN Spezialstahl gehärtet Toleranz ± 0,002mm



- ▶ DIN 2269
- ▶ Härte 60 ±2 HRC
- ▶ > Ø 1,50mm mit Fase
- ▶ Ab Ø 2,00mm mit Nennmaß beschriftet
- ▶ Lieferung einzeln verpackt

Pin gauges singles, SPECIAL LENGTHS Hardened special steel Tolerance ± 0.002mm

- ▶ DIN 2269
- ▶ Hardness 60 ±2 HRC
- ▶ > Ø 1.50mm with chamfer
- ▶ Nominal size marked from Ø 2.00mm
- ▶ Delivered in individual packages



Stufung Ø 0,01 mm
Step Ø 0.01 mm

Stufung Länge 1mm
Step Length 1mm



No. 1069...zm1 kurz / short

No. 1069...zm2 lang / long

No. 1069...zm3 sehr lang / very long

NEW

NUR bei ULTRA!

Sonderlängen bis 200mm!

ONLY at ULTRA!

Special lengths up to 200mm!

1069 ... zm1:

Prüfstifte kurz

1069 ... zm1:

Pin gauges, short

1069 ... zm2:

Prüfstifte lang

1069 ... zm2:

Pin gauges, long

1069 ... zm3:

Prüfstifte sehr lang

1069 ... zm3:

Pin gauges, very long

! Noch größere Längen auf Anfrage.

! Even larger lengths on request.

! **Bestellhinweis:** bitte das exakte Nennmaß und die Länge angeben, z.B. Ø 0,30mm und L 20mm, Ø 7,50mm und L 100mm oder Ø 40,32mm und L 200mm.

! **Order notice:** Please enter the exact nominal size and the length, e.g. Ø 0.30mm and L 20mm, Ø 7.50mm and L 100mm or Ø 40.32mm and L 200mm.

Alle Preise abzüglich Rabatt! / Rabatt anfragen
All prices less discount! / Ask for discount

+49 (0) 6021 42999 00

-%

Ø 0,01 mm	1 mm	±0,002mm Nº		1 mm	±0,002mm Nº		1 mm	±0,002mm Nº	
0,10 – 0,14	20 – 39	1069099zm1	44,00 €	41 – 60	1069099zm2	88,00 €	–	–	–
0,15 – 0,29	20 – 39	1069100zm1	43,20 €	41 – 60	1069100zm2	86,50 €	–	–	–
0,30 – 0,49	20 – 39	1069100xzm1	21,80 €	41 – 60	1069100xzm2	43,60 €	–	–	–
0,50 – 0,99	20 – 39	1069101zm1	10,50 €	41 – 70	1069101zm2	21,00 €	–	–	–
1,00 – 2,99	20 – 69	1069201zm1	8,70 €	71 – 100	1069201zm2	34,80 €	101 – 150	1069201zm3	87,00 €
3,00 – 5,99	20 – 69	1069301zm1	11,40 €	71 – 100	1069301zm2	45,60 €	101 – 200	1069301zm3	114,00 €
6,00 – 9,99	20 – 69	1069401zm1	14,20 €	71 – 100	1069401zm2	57,00 €	101 – 200	1069401zm3	142,00 €
10,00 – 11,99	20 – 69	1069501zm1	19,00 €	71 – 100	1069501zm2	76,00 €	101 – 200	1069501zm3	190,00 €
12,00 – 13,99	20 – 69	1069601zm1	22,40 €	71 – 100	1069601zm2	90,00 €	101 – 200	1069601zm3	224,00 €
14,00 – 15,99	20 – 69	1069701zm1	27,90 €	71 – 100	1069701zm2	112,00 €	101 – 200	1069701zm3	279,00 €
16,00 – 18,99	20 – 69	1069801zm1	32,80 €	71 – 100	1069801zm2	132,00 €	101 – 200	1069801zm3	328,00 €
19,00 – 20,00	20 – 69	1069901zm1	37,60 €	71 – 100	1069901zm2	151,00 €	101 – 200	1069901zm3	376,00 €
20,01 – 21,99	20 – 69	1069902zm1	196,00 €	71 – 100	1069902zm2	392,00 €	101 – 200	1069902zm3	706,00 €
22,00 – 23,99	20 – 69	1069903zm1	216,00 €	71 – 100	1069903zm2	432,00 €	101 – 200	1069903zm3	778,00 €
24,00 – 24,99	20 – 69	1069904zm1	234,00 €	71 – 100	1069904zm2	468,00 €	101 – 200	1069904zm3	843,00 €
25,00 – 26,99	20 – 69	1069905zm1	356,00 €	71 – 100	1069905zm2	712,00 €	101 – 200	1069905zm3	1.282,00 €
27,00 – 31,99	20 – 69	1069906zm1	399,00 €	71 – 100	1069906zm2	798,00 €	101 – 200	1069906zm3	1.437,00 €
32,00 – 36,99	20 – 69	1069907zm1	428,00 €	71 – 100	1069907zm2	856,00 €	101 – 200	1069907zm3	1.541,00 €
37,00 – 39,99	20 – 69	1069908zm1	462,00 €	71 – 100	1069908zm2	924,00 €	101 – 200	1069908zm3	1.664,00 €
40,00 – 50,00	20 – 69	1069909zm1	542,00 €	71 – 100	1069909zm2	1.084,00 €	101 – 200	1069909zm3	1.952,00 €

NEW

Prüfstifte aus Stahl / Pin gauges made of steel



20mm – 200mm in mm Stufung! / in mm steps!



Längen von 20 bis 200mm in 1mm Stufung jetzt im Shop bestellbar! / Length from 20 up to 200mm in 1mm steps now available in our shop!



**Prüfstifte einzeln,
SONDERLÄNGEN**
Spezialstahl gehärtet
Toleranz ± 0,001mm



- ▶ DIN 2269
- ▶ Härte 60 ±2 HRC
- ▶ > Ø 1,500mm mit Fase
- ▶ Ab Ø 2,000mm mit Nennmaß beschriftet
- ▶ Lieferung einzeln verpackt

1068 ... zm1:
Prüfstifte kurz

1068 ... zm2:
Prüfstifte lang

1068 ... zm3:
Prüfstifte sehr lang

! Noch größere Längen auf Anfrage.

! **Bestellhinweis:** bitte das exakte Nennmaß und die Länge angeben, z.B. Ø 0,252mm und L 38mm, Ø 12,892mm und L 80mm oder Ø 35,329mm und L 100mm.

**Pin gauges singles,
SPECIAL LENGTHS**
Hardened special steel
Tolerance ± 0.001mm

- ▶ DIN 2269
- ▶ Hardness 60 ±2 HRC
- ▶ > Ø 1.500mm with chamfer
- ▶ Nominal size marked from Ø 2.000mm
- ▶ Delivered in individual packages

1068 ... zm1:
Pin gauges, short

1068 ... zm2:
Pin gauges, long

1068 ... zm3:
Pin gauges, very long

! Even larger lengths on request.

! **Order notice:** Please enter the exact nominal size and the length, e.g. Ø 0.252mm and L 38mm, Ø 12.892mm and L 80mm or Ø 35.329mm and L 100mm.



Stufung Ø 0,001 mm
Step Ø 0,001 mm

Stufung Länge 1mm
Step Length 1mm



No. 1068...zm1 kurz / short
No. 1068...zm2 lang / long
No. 1068...zm3 sehr lang / very long

NEW

NUR bei ULTRA!
Sonderlängen bis 150mm!
ONLY at ULTRA!
Special lengths up to 150mm!

Alle Preise abzüglich Rabatt! / Rabatt anfragen
All prices less discount! / Ask for discount

+49 (0) 6021 42999 00

-%

Ø 0,001 mm	1 mm	±0,001mm Nº	90,00 €	1 mm	±0,001mm Nº	135,00 €	1 mm	±0,001mm Nº	
0,100 – 0,149	20 – 39	1068099zm1	90,00 €	41 – 60	1068099zm2	135,00 €	–	–	–
0,150 – 0,299	20 – 39	1068100zm1	63,00 €	41 – 60	1068100zm2	94,50 €	–	–	–
0,300 – 0,499	20 – 39	1068100xzm1	44,10 €	41 – 60	1068100xzm2	66,50 €	–	–	–
0,500 – 0,999	20 – 39	1068101zm1	46,70 €	41 – 70	1068101zm2	70,50 €	–	–	–
1,000 – 4,999	20 – 69	1068201zm1	58,00 €	71 – 100	1068201zm2	87,00 €	101 – 150	1068201zm3	174,00 €
5,000 – 6,999	20 – 69	1068301zm1	64,00 €	71 – 100	1068301zm2	96,00 €	101 – 150	1068301zm3	192,00 €
7,000 – 9,999	20 – 69	1068401zm1	71,00 €	71 – 100	1068401zm2	107,00 €	101 – 150	1068401zm3	213,00 €
10,000 – 11,999	20 – 69	1068501zm1	83,00 €	71 – 100	1068501zm2	125,00 €	101 – 150	1068501zm3	249,00 €
12,000 – 13,999	20 – 69	1068601zm1	101,00 €	71 – 100	1068601zm2	233,00 €	101 – 150	1068601zm3	465,00 €
14,000 – 15,999	20 – 69	1068701zm1	128,00 €	71 – 100	1068701zm2	295,00 €	101 – 150	1068701zm3	589,00 €
16,000 – 17,999	20 – 69	1068801zm1	140,00 €	71 – 100	1068801zm2	322,00 €	101 – 150	1068801zm3	805,00 €
18,000 – 20,000	20 – 69	1068901zm1	179,00 €	71 – 100	1068901zm2	484,00 €	101 – 150	1068901zm3	1.209,00 €
20,001 – 21,999	20 – 69	1068902zm1	342,00 €	71 – 100	1068902zm2	684,00 €	–	–	–
22,000 – 23,999	20 – 69	1068903zm1	376,00 €	71 – 100	1068903zm2	752,00 €	–	–	–
24,000 – 24,999	20 – 69	1068904zm1	395,00 €	71 – 100	1068904zm2	790,00 €	–	–	–
25,000 – 26,999	20 – 69	1068905zm1	653,00 €	71 – 100	1068905zm2	1.306,00 €	–	–	–
27,000 – 31,999	20 – 69	1068906zm1	699,00 €	71 – 100	1068906zm2	1.398,00 €	–	–	–
32,000 – 36,999	20 – 69	1068907zm1	804,00 €	71 – 100	1068907zm2	1.608,00 €	–	–	–
37,000 – 40,000	20 – 69	1068908zm1	894,00 €	71 – 100	1068908zm2	1.788,00 €	–	–	–

Wussten Sie schon? Did you know?

Wir liefern Aluminiumgriffe mit Spannzangen für Prüfstifte bis Ø 25mm, inkl. individueller Beschriftung der Durchmesser und Toleranzen. In Verbindung mit unseren Prüfstiften, können Sie Grenzlehndorne selbst zusammensetzen.

We supply aluminium handles with collets for pin gauges up to Ø 25mm, incl. individually marked diameter and tolerance. For our pin gauges you can compose limit plug gauges by yourselves.



Prüfstiftsätze aus Hartmetall



- ▶ DIN 2269
- ▶ Härte 90-93 HRA
- ▶ > Ø 1,50mm mit Fase
- ▶ Ab Ø 2,00mm mit Nennmaß beschriftet
- ▶ Inklusive zusätzlichen Kunststoffhülsen pro Stift mit Nennmaßbeschriftung
- ▶ Lieferung im Holzetui

Pin gauge sets, tungsten carbide

- ▶ DIN 2269
- ▶ Hardness 90-93 HRA
- ▶ > Ø 1.50mm with chamfer
- ▶ Nominal size marked from Ø 2.00mm
- ▶ Including additional plastic sleeves per pin with marking of nominal size
- ▶ Delivered in wooden box



Hartmetall
Tungsten carbide

PROMO
→ 31.12.2025!

Ø mm	mm	mm	Stück Pieces	kg	±0,001mm №	Listenpreis Listprice	Aktionspreis Promotion price
0,50 – 1,00	0,01	50	51	1,83	1075203	1.100,00 €	885,00 €
1,00 – 5,00	0,05	50	81	1,5	1075204x	1.728,00 €	1.396,00 €
1,00 – 5,00	0,1	50	41	1,97	1075205x	906,00 €	801,00 €
1,00 – 10,00	0,1	50	91	4,5	1075205	2.543,00 €	2.162,00 €
5,05 – 10,00	0,05	50	100	3,8	1075208	3.563,00 €	2.995,00 €
1,00 – 2,00	0,01	50	101	1,9	1075215	1.656,00 €	1.380,00 €
2,01 – 3,00	0,01	50	100	2,1	1075216	2.003,00 €	1.483,00 €
3,01 – 4,00	0,01	50	100	2,3	1075217	2.134,00 €	1.827,00 €
4,01 – 5,00	0,01	50	100	2,6	1075218	2.640,00 €	1.998,00 €
5,01 – 6,00	0,01	50	100	2,9	1075219	3.069,00 €	2.121,00 €
6,01 – 7,00	0,01	50	100	3,8	1075220	3.651,00 €	2.524,00 €
7,01 – 8,00	0,01	50	100	4,3	1075221	3.770,00 €	2.874,00 €
8,01 – 9,00	0,01	50	100	4,9	1075222	3.973,00 €	3.224,00 €
9,01 – 10,00	0,01	50	100	5,8	1075223	4.410,00 €	3.578,00 €

% Rabatt
Discount

% Wichtiger Bestellhinweis % Ihr regulärer Rabatt gilt auch für die bereits reduzierten Aktionspreise!
% Important order notice % Your regular discount also applies to the already reduced promotional prices!



No. 1075217



Inklusive Schutzhülsen
Including protection sleeves

Prüfstifte einzeln, STANDARDLÄNGEN Hartmetall mit Stufung 0,001mm



▶ Siehe oben

Pin gauges singles, STANDARD LENGTHS Tungsten Carbide with step 0.001mm

▶ See above



Hartmetall, Stufung 0,001mm
Tungsten carbide, step 0.001mm

No. 1075...

NEW

**JETZT BIS Ø 40,000mm!
NOW UP TO Ø 40.000mm!**

10750.. :

Toleranz ± 0,0005mm

10750.. :

Tolerance ± 0.0005mm

10751.. :

Toleranz ± 0,001mm

10751.. :

Tolerance ± 0.001mm

! **Bestellhinweis:** bitte das exakte Nennmaß angeben, z.B. Ø 4,829mm, Ø 23,998mm oder Ø 35,780mm.

! **Order notice:** Please enter the exact nominal size, e.g. Ø 4.829mm, Ø 23.998mm or Ø 35.780mm.

Alle Preise abzüglich Rabatt! / Rabatt anfragen
All prices less discount! / Ask for discount

+49 (0) 6021 42999 00

-%

Ø mm	mm	mm	±0,0005mm №	Price
0,500 – 0,999	0,001	40	1075053	100,00 €
1,000 – 4,999	0,001	70	1075054	210,00 €
5,000 – 6,999	0,001	70	1075055	245,00 €
7,000 – 9,999	0,001	70	1075056	288,00 €
10,000 – 11,999	0,001	70	1075057	385,00 €
12,000 – 13,999	0,001	70	1075058	494,00 €
14,000 – 15,999	0,001	70	1075059	636,00 €

Ø mm	mm	mm	±0,001mm №	Price
0,500 – 0,999	0,001	40	1075101	46,70 €
1,000 – 2,999	0,001	70	1075102	66,50 €
3,000 – 4,999	0,001	70	1075103	76,00 €
5,000 – 6,999	0,001	70	1075104	94,50 €
7,000 – 8,999	0,001	70	1075105	105,00 €
9,000 – 9,999	0,001	70	1075106	122,00 €
10,000 – 11,999	0,001	70	1075107	189,00 €
12,000 – 13,999	0,001	70	1075108	244,00 €
14,000 – 15,999	0,001	70	1075109	299,00 €
16,000 – 17,999	0,001	70	1075110	353,00 €
18,000 – 20,000	0,001	70	1075111	457,00 €
20,001 – 21,999	0,001	70	1075112	580,00 €
22,000 – 23,999	0,001	70	1075113	692,00 €
24,000 – 24,999	0,001	70	1075114	748,00 €
25,000 – 26,999	0,001	70	1075115	867,00 €
27,000 – 31,999	0,001	70	1075116	1.404,00 €
32,000 – 36,999	0,001	70	1075117	1.624,00 €
37,000 – 40,000	0,001	70	1075118	1.799,00 €

**Prüfstifte einzeln,
STANDARDLÄNGEN
Keramik
mit Stufung 0,001mm**



- ▶ DIN 2269
- ▶ Härte 89-90 HRA
- ▶ extrem hart, korrosionsbeständig und absolut verschleißfest
- ▶ > Ø 1,500mm mit Fase
- ▶ ab Ø 2,000mm mit Nennmaß beschriftet
- ▶ Lieferung einzeln verpackt

10760.. :

Toleranz ± 0,0005mm

10761.. :

Toleranz ± 0,001mm

! Bestellhinweis: bitte das exakte Nennmaß angeben, z.B. Ø 2,521mm, Ø 19,998mm oder Ø 38,795mm.

**Pin gauges singles,
STANDARD LENGTHS
Ceramic
with step 0.001mm**

- ▶ DIN 2269
- ▶ Hardness 89-90 HRA
- ▶ Extremely hard, anti-corrosive and absolutely wear-resistant
- ▶ > Ø 1.500mm with chamfer
- ▶ Nominal size marked from Ø 2.000mm
- ▶ Delivered in individual packages

10760.. :

Tolerance ± 0.0005mm

10761.. :

Tolerance ± 0.001mm

! Order notice: Please enter the exact nominal size, e.g. Ø 2.521mm, Ø 19.998mm or Ø 38.795mm.



Keramik, Stufung 0,001mm
Ceramic, step 0.001mm

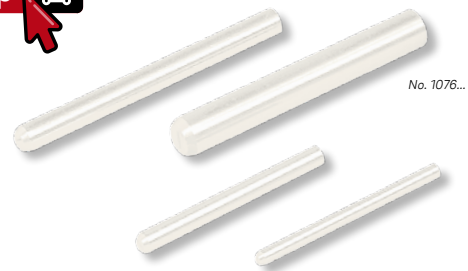

NEW

**JETZT BIS Ø 40,000mm!
NOW UP TO Ø 40.000mm!**

Alle Preise abzüglich Rabatt! / Rabatt anfragen
All prices less discount! / Ask for discount

+49 (0) 6021 42999 00

-%

Ø mm	mm	mm	±0,0005mm №	
0,500 – 0,999	0,001	40	1076053	110,00 €
1,000 – 4,999	0,001	70	1076054	231,00 €
5,000 – 6,999	0,001	70	1076055	270,00 €
7,000 – 9,999	0,001	70	1076056	317,00 €
10,000 – 11,999	0,001	70	1076057	424,00 €
12,000 – 13,999	0,001	70	1076058	544,00 €
14,000 – 15,999	0,001	70	1076059	700,00 €

Ø mm	mm	mm	±0,001mm №	
0,500 – 0,999	0,001	40	1076101	51,50 €
1,000 – 2,999	0,001	70	1076102	75,50 €
3,000 – 4,999	0,001	70	1076103	87,00 €
5,000 – 6,999	0,001	70	1076104	114,00 €
7,000 – 8,999	0,001	70	1076105	126,00 €
9,000 – 9,999	0,001	70	1076106	142,00 €
10,000 – 11,999	0,001	70	1076107	210,00 €
12,000 – 13,999	0,001	70	1076108	268,00 €
14,000 – 15,999	0,001	70	1076109	330,00 €
16,000 – 17,999	0,001	70	1076110	390,00 €
18,000 – 20,000	0,001	70	1076111	505,00 €
20,001 – 21,999	0,001	70	1076112	638,00 €
22,000 – 23,999	0,001	70	1076113	761,00 €
24,000 – 24,999	0,001	70	1076114	823,00 €
25,000 – 26,999	0,001	70	1076115	953,00 €
27,000 – 31,999	0,001	70	1076116	1.544,00 €
32,000 – 36,999	0,001	70	1076117	1.786,00 €
37,000 – 40,000	0,001	70	1076118	1.979,00 €

**Aluminium-Sechskantgriffe
für Prüfstifte**



- ▶ Aluminium, Sechskant-Profil, schwarz
- ▶ Klemmung der Prüfstifte durch seitliche Madenschraube
- ▶ Kompatibel zu allen Prüfstiften, 15mm der Prüfstiftlänge werden als Klemmfläche benötigt
- ▶ Inkl. Beschriftung der Nenndurchmesser, gemäß Ihrer Vorgabe
- ▶ Kennzeichnung ID-Nummer gegen Aufpreis
- ▶ Lieferung einzeln verpackt

! Bestellhinweis: bitte den exakten Nenndurchmesser eingeben, z.B. Ø 7,58mm oder Ø 12,495mm.

**Hexagonal aluminium handles
for pin gauges**

- ▶ Aluminium, hexagonal profile, black
- ▶ Clamping of the pin gauges by means of a screw on the side surface
- ▶ Suitable for all pin gauges, 15mm of the pin gauge length will be need as clamping surface
- ▶ Incl. marking of the nominal diameters, according to your requirement
- ▶ Marking of an ID-number against extra charge
- ▶ Delivered in individual packages

! Order notice: Please enter exact nominal diameter, e.g. Ø 7.58mm or Ø 12.495mm.



Alle Preise abzüglich Rabatt! / Rabatt anfragen
All prices less discount! / Ask for discount

+49 (0) 6021 42999 00

-%

für / for Ø mm	mm	№	
0,100 – 0,399	30	1063201	33,60 €
0,400 – 10,000	30	1063202	23,50 €
10,001 – 15,000	30	1063203	35,20 €
15,001 – 20,000	30	1063204	36,30 €

Parallel-Endmaßsätze Spezialstahl, gehärtet



- ▶ DIN EN ISO 3650
- ▶ Genauigkeit 0, 1 oder 2
- ▶ jedes Endmaß mit Nennmaß und Ident-Nr. signiert
- ▶ Lieferung im Holzetui inkl. Herstellerzertifikat

Gauge block sets Hardened special steel

- ▶ DIN EN ISO 3650
- ▶ Accuracy grade 0, 1 or 2
- ▶ Each gauge block marked with nominal size and identity number
- ▶ Delivered in wooden box incl. manufacturer certificate



Alle Preise abzüglich Rabatt! / Rabatt anfragen
All prices less discount! / Ask for discount

+49 (0) 6021 42999 00

-%

Stück Pieces	mm	mm	kg	GG	Nº	
32	1,005	-	1,2	0	1006410	425,00 €
	1,01 - 1,09	0,01			1007410	287,00 €
	1,1 - 1,9	0,1			1008410	161,00 €
	1,0 - 9,0	1,0				
	10 / 20 / 30 / 50	-				
47	1,005	-	1,5	0	1006421	658,00 €
	1,01 - 1,20	0,01			1007421	379,00 €
	1,3 - 1,9	0,1			1008421	253,00 €
	1,0 - 9,0	1,0				
	10 - 100	10,0				
87	1,001 - 1,009	0,001	3,5	0	1006431	1.023,00 €
	1,01 - 1,49	0,01			1007431	649,00 €
	0,5 - 9,5	0,5			1008431	363,00 €
	10 - 100	10,0				

Stück Pieces	mm	mm	kg	GG	Nº	
103	1,005	-	4,3	0	1006435	1.204,00 €
	1,01 - 1,49	0,01			1007435	782,00 €
	0,5 - 24,5	0,5			1008435	441,00 €
	25 - 100	25				
112	1,0005	-	3,8	0	1006440	1.482,00 €
	1,001 - 1,009	0,001			1007440	1.200,00 €
	1,01 - 1,49	0,01			1008440	542,00 €
	0,5 - 24,5	0,5				
	25 - 100	25				
122	1,0005	-	4,2	0	1006445	1.897,00 €
	1,001 - 1,009	0,001			1007445	1.563,00 €
	1,01 - 1,49	0,01			1008445	603,00 €
	0,5 / 1,0 / 1,5 - 1,9	0,1				
	2 - 25	0,5				
	30 - 100	10				
	75	-				

Parallel-Endmaßsätze Keramik



- ▶ DIN EN ISO 3650
- ▶ Genauigkeit 0 oder 1
- ▶ jedes Endmaß mit Nennmaß und Ident-Nr. signiert
- ▶ Lieferung im Holzetui inkl. Herstellerzertifikat

Gauge block sets Ceramic

- ▶ DIN EN ISO 3650
- ▶ Accuracy grade 0 or 1
- ▶ Each gauge block marked with nominal size and identity number
- ▶ Delivered in wooden box incl. manufacturer certificate



Alle Preise abzüglich Rabatt! / Rabatt anfragen
All prices less discount! / Ask for discount

+49 (0) 6021 42999 00

-%

Stück Pieces	mm	mm	kg	GG	Nº	
32	1,005	-	1,2	0	1016410	1.835,00 €
	1,01 - 1,09	0,01			1017410	1.241,00 €
	1,1 - 1,9	0,1				
	1,0 - 9,0	1,0				
	10 / 20 / 30 / 50	-				
47	1,005	-	1,5	0	1016421	2.640,00 €
	1,01 - 1,20	0,01			1017421	1.912,00 €
	1,3 - 1,9	0,1				
	1,0 - 9,0	1,0				
	10 - 100	10,0				
87	1,001 - 1,009	0,001	3,5	0	1016431	4.964,00 €
	1,01 - 1,49	0,01			1017431	3.225,00 €
	0,5 - 9,5	0,5				
	10 - 100	10,0				

Stück Pieces	mm	mm	kg	GG	Nº	
103	1,005	-	4,3	0	1016435	5.456,00 €
	1,01 - 1,49	0,01			1017435	4.411,00 €
	0,5 - 24,5	0,5				
	25 - 100	25				
122	1,0005	-	4,5	0	1016445	7.059,00 €
	1,001 - 1,009	0,001			1017445	5.630,00 €
	1,01 - 1,49	0,01				
	0,5 / 1,0 / 1,5 - 1,9	0,1				
	2 - 25	0,5				
	30 - 100	10				
	75	-				

**Parallel-Endmaßsätze
Spezialstahl, gehärtet
inkl. Einstellringe**



- ▶ DIN EN ISO 3650 und DIN 2250-C
- ▶ Zum Prüfen von Messschiebern und Höhenreißern
- ▶ Endmaße in Genauigkeit 1
- ▶ jedes Endmaß mit Nennmaß und Ident-Nr. signiert
- ▶ Lieferung im Holzsetui

▮ Andere Satzzusammenstellungen siehe Shop.

**Gauge block sets
Hardened special steel
incl. setting rings**

- ▶ DIN EN ISO 3650 and DIN 2250-C
- ▶ For checking calipers and marking gauges
- ▶ Gauge blocks in accuracy grade 1
- ▶ Each gauge block marked with nominal size and identity number
- ▶ Delivered in wooden box

▮ Other set compositions see shop.

NEW

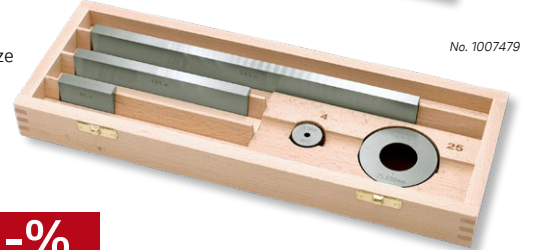

Alle Preise abzüglich Rabatt! / Rabatt anfragen **+49 (0) 6021 42999 00** **-%**
All prices less discount! / Ask for discount

Stück Pieces	Einstellring Setting ring	■ mm	■ kg	Ⓒ	Nº	
5	Ø 4,0 / Ø 25,0mm	30,0 41,3 131,4	1,2	1	1007478	266,00 €
		41,3 131,4 243,5	2,0		1007479	450,00 €

**Parallel-Endmaßsätze
inkl. Planglas**



- ▶ DIN EN ISO 3650
- ▶ zum Prüfen von Messschrauben
- ▶ Endmaße in Genauigkeit 1
- ▶ jedes Endmaß mit Nennmaß und Ident-Nr. signiert
- ▶ Lieferung im Holzsetui

1007500 + 1007501:
Endmaße aus Spezialstahl, inkl. Planglas

1018109 + 1018110:
Endmaße aus Keramik, inkl. Planglas

**Gauge block sets
incl. optical flat**



- ▶ DIN EN ISO 3650
- ▶ For checking micrometers
- ▶ Gauge blocks in accuracy grade 1
- ▶ Each gauge block marked with nominal size and identity number
- ▶ Delivered in wooden box

1007500 + 1007501:
Gauge blocks, special steel, incl. optical flat

1018109 + 1018110:
Gauge blocks, ceramic, incl. optical flat

NEW



Alle Preise abzüglich Rabatt! / Rabatt anfragen **+49 (0) 6021 42999 00** **-%**
All prices less discount! / Ask for discount

Stück Pieces	Planglas Optical flat	■ mm	■ kg	Ⓒ	Nº	Nº		
6	Ø 32 x 12mm	5,1 10,3 15,0 20,2 25,0	0,6	1	1007500	205,00 €	1018109	962,00 €
		5,1 10,3 15,0 20,2 25,0 50,0 75,0 100,0			1,2	1	1007501	269,00 €

Grenzlehndorne, vollzylindrisch Sondermaße, Zwischenmaße



- ▶ DIN 2245 bis Ø 65,000mm (Gut- und Ausschussseite in einer Lehre)
- ▶ DIN 2246 / 2247 > Ø 65,000mm (Gut- und Ausschussseite getrennt, Paar)
- ▶ ISO Toleranzfelder A-ZC, Qualitäten ≥ 6, alle Zwischenmaße, alle zahlenmäßige Toleranzen bis einschließlich Toleranzqualität IT6
- ▶ Gut- und Ausschussseite
- ▶ Lehenstahl gehärtet
- ▶ Lieferung einzeln verpackt

Bestellhinweis: bitte den exakten Nenndurchmesser eingeben, z.B. Ø 7,58mm oder Ø 20,495mm, sowie die gewünschte Toleranz z.B. H6 oder O/+0,05mm

Limit plug gauges, cylindrical full form Special sizes, intermediate sizes

- ▶ DIN 2245 until Ø 65.000mm (GO and NO-GO sides on one gauge)
- ▶ DIN 2246 / 2247 > Ø 65.000mm (Separate GO and NO-GO sides, pair)
- ▶ ISO Tolerance A-ZC, Qualities ≥ 6, all intermediate dimensions, all numerical tolerances up to and including tolerance quality IT6
- ▶ GO and NO-GO side
- ▶ Hardened tool steel
- ▶ Delivered in individual packages

Order notice: Please enter exact nominal diameter, e.g. Ø 7.58mm oder Ø 20.495mm, as well as the required tolerance e.g. H6 or O/+0.05mm



No. 10812...zm

Alle Preise abzüglich Rabatt! / Rabatt anfragen
All prices less discount! / Ask for discount

+49 (0) 6021 42999 00

-%

Ø mm	mm	Nº	
1,000 - 2,000	0,001	1081200zm	98,00 €
2,001 - 3,000	0,001	1081201zm	52,00 €
3,001 - 6,000	0,001	1081202zm	47,50 €
6,001 - 10,000	0,001	1081203zm	48,00 €
10,001 - 14,000	0,001	1081204zm	53,00 €
14,001 - 18,000	0,001	1081205zm	59,50 €
18,001 - 24,000	0,001	1081206zm	66,00 €
24,001 - 30,000	0,001	1081207zm	75,00 €

Ø mm	mm	Nº	
30,001 - 35,000	0,001	1081208zm	90,00 €
35,001 - 40,000	0,001	1081209zm	96,50 €
40,001 - 44,000	0,001	1081210zm	136,00 €
44,001 - 50,000	0,001	1081211zm	142,00 €
50,001 - 60,000	0,001	1081212zm	178,00 €
60,001 - 68,000	0,001	1081213zm	252,00 €
68,001 - 70,000	0,001	1081214zm	255,00 €
70,001 - 76,000	0,001	1081215zm	276,00 €

Ø mm	mm	Nº	
76,001 - 87,000	0,001	1081216zm	308,00 €
87,001 - 90,000	0,001	1081217zm	316,00 €
90,001 - 100,000	0,001	1081218zm	343,00 €
100,001 - 105,000	0,001	1081219zm	440,00 €
105,001 - 110,000	0,001	1081220zm	475,00 €
110,001 - 115,000	0,001	1081221zm	501,00 €
115,001 - 120,000	0,001	1081222zm	529,00 €

Grenzlehndorn-Sätze



- ▶ DIN 2245
- ▶ Passung H7
- ▶ Gut- und Ausschussseite, vollzylindrisch
- ▶ Lehenstahl gehärtet
- ▶ Gutseite mit Abnutzungsaufmaß (Arbeitslehre)
- ▶ Lieferung im Etui

Limit plug gauge sets

- ▶ DIN 2245
- ▶ Tolerance H7
- ▶ GO and NO-GO side, fully cylindrical
- ▶ Hardened tool steel
- ▶ GO side with wear allowance (workshop gauge)
- ▶ Delivered in a case



No. 1080201

Alle Preise abzüglich Rabatt! / Rabatt anfragen
All prices less discount! / Ask for discount

+49 (0) 6021 42999 00

-%

Ø mm	kg	Nº	
3 / 4 / 5 / 6 / 8 / 10 / 12	0,46	1080201	164,00 €

Wussten Sie schon? Did you know?

Verzahnungslehndorne und -ringe für Keilnaben- und Keilwellenprofile oder Kerb- und Evolventenverzahnung, z.B. DIN 5462 / 5463 / 5464 / 5471 / 5472 / 5481 / 5482 auf Anfrage lieferbar.

Bitte die kompletten Verzahnungsdaten oder Fertigungs- bzw. Werkstückzeichnungen an info@ultra-germany.com senden.

Wir erstellen Ihnen gerne ein Angebot.

Spline plug gauges or ring gauges for serration and involute toothing or hubs and shaft profiles acc. to DIN 5462 / 5463 / 5464 / 5471 / 5472 / 5481 / 5482 deliverable on request.

Please send the complete spline data or manufacturing / workpiece drawings to info@ultra-germany.com and are looking forward to receive your inquires.

We will be happy to provide you with an offer.



Grenzlehndorne für Innensechsrundprüfung (6-Lobe)



- ▶ ISO 10664 (Vormäßlehren angelehnt an ISO)
- ▶ Gut- und Ausschusseite
- ▶ Lehrenstahl gehärtet
- ▶ zum Prüfen der Maßhaltigkeit und Geometrie von Schraubenköpfen (Innenmessung)
- ▶ Lieferung einzeln verpackt

1095100 – 1095112 :

Vormäßlehren, vor Beschichtung

1095200 – 1095212 :

Fertigmaßlehren, nach Beschichtung

- ! Andere Größen, einseitige Lehndorne (Gut- oder Ausschuss), Prüflehren für Eindringtiefen sowie Bit-Prüflehren auf Anfrage.

Limit plug gauges for internal hexalobular checking (6-Lobe)

- ▶ ISO 10664 (in process gauges based on ISO)
- ▶ GO and NO-GO side
- ▶ Hardened tool steel
- ▶ To check accuracy and the geometric compliance of internal screw heads
- ▶ Delivered in individual packages

1095100 – 1095112 :

In process gauges, before coating

1095200 – 1095212 :

Final inspection gauges, after coating

- ! Other sizes, single sided plugs (GO or NO-GO), penetration gauges as well as bit gauges on request.



NEW

**Mehr Größen!
More sizes!**

Alle Preise abzüglich Rabatt! / Rabatt anfragen
All prices less discount! / Ask for discount

+49 (0) 6021 42999 00

-%

6-Lobe	Vormäßlehre In process gauge №		Fertigmaßlehre Final inspection gauge №	
1	1095100	1.399,00 €	1095200	1.399,00 €
2 / 3 / 4 / 5	1095101	817,00 €	1095201	817,00 €
6 / 7 / 8 / 9	1095102	676,00 €	1095202	676,00 €
10	1095103	676,00 €	1095203	676,00 €
15	1095104	676,00 €	1095204	676,00 €
20	1095105	676,00 €	1095205	676,00 €
25	1095106	638,00 €	1095206	638,00 €
27	1095106x	650,00 €	1095206x	650,00 €
30	1095107	676,00 €	1095207	676,00 €
40	1095108	742,00 €	1095208	742,00 €
45	1095109	742,00 €	1095209	742,00 €
50	1095110	857,00 €	1095210	857,00 €
55	1095110x	857,00 €	1095210x	857,00 €
60	1095111	857,00 €	1095211	857,00 €
70	1095112	998,00 €	1095212	998,00 €
80	1095113	1.010,00 €	1095213	1.010,00 €
90	1095114	1.020,00 €	1095214	1.020,00 €
100	1095115	1.049,00 €	1095215	1.049,00 €

💡 Wussten Sie schon? Did you know?

Sie benötigen Gewindelehren? Und dies möglichst schnell? ULTRA hat die Lösung! Egal ob metrisches Regel- oder Feingewinde, amerikanisches Gewinde, Trapezgewinde usw. Durch mehrere Optimierungen können wir einen Großteil der Gewindelehren innerhalb von 1 Arbeitswoche liefern - Zwischenverkauf vorbehalten.

ULTRA Always One Step Ahead!
Extrem schnelle Lieferzeiten für Gewindelehren.

Alle Gewindelehren finden Sie im Shop. Jetzt kostenlos registrieren!
Im Anschluss erscheinen im Shop Ihre persönlichen Nettopreise. Ihr Rabatt wurde dann bereits in Abzug gebracht.

You require individual thread gauges? As soon as possible? ULTRA has the solution! It doesn't matter if you need metric threads or metric fine threads, thread gauges to American Standard, trapezoidal threads etc. We optimized this sector and can now deliver most gauges within 1 working week - subject to prior sale.

ULTRA Always One Step Ahead!
Extremely fast delivery times for thread gauges.

You can find all thread gauges in the online shop. Register now free of charge!
After registration, your personal net prices will automatically appear in our shop. Your discount has already been deducted.



Rundlaufprüfdorne ULTRA *active* für SK-Spindeln



- ▶ ISO 7388-1 (DIN 69871)
- ▶ Lehenstahl gehärtet
- ▶ Rundlaufgenauigkeit und Zylindrizität 0,003mm
- ▶ Lieferung einzeln verpackt

Concentricity test plug gauges ULTRA *active* for SK spindles

- ▶ ISO 7388-1 (DIN 69871)
- ▶ Hardened tool steel
- ▶ Concentricity and cylindricity 0.003mm
- ▶ Delivered in individual packages

NEW



No. 1125652

Alle Preise abzüglich Rabatt! / Rabatt anfragen
All prices less discount! / Ask for discount **+49 (0) 6021 42999 00** **-%**

Größe Size	Ø mm	L mm	W kg	Nº	
SK 30	32	250	1,5	1125651	405,00 €
SK 40	40	300	2,6	1125652	426,00 €
SK 50	40	300	4,8	1125653	519,00 €

Rundlaufprüfdorne ULTRA *active* für HSK-Spindeln



- ▶ ISO 12164 (DIN 69893)
- ▶ Lehenstahl gehärtet
- ▶ Rundlaufgenauigkeit und Zylindrizität 0,003mm
- ▶ Lieferung einzeln verpackt

Concentricity test plug gauges ULTRA *active* for HSK spindles

- ▶ ISO 12164 (DIN 69893)
- ▶ Hardened tool steel
- ▶ Concentricity and cylindricity 0.003mm
- ▶ Delivered in individual packages

NEW



No. 1125754

█ HSK Form E oder F auf Anfrage.

█ HSK form E or F on request.

Alle Preise abzüglich Rabatt! / Rabatt anfragen
All prices less discount! / Ask for discount **+49 (0) 6021 42999 00** **-%**

Größe Size	Ø mm	L mm	W kg	Nº	
HSK 32 Form A	25	200	1,1	1125751	479,00 €
HSK 40 Form A	25	200	2,8	1125752	497,00 €
HSK 63 Form A	40	300	4,6	1125754	555,00 €

Rundlaufprüfdorne ULTRA *active* für BT-Spindeln



- ▶ ISO 7388-2 (JIS 6339 / MAS-BT)
- ▶ Lehenstahl gehärtet
- ▶ Rundlaufgenauigkeit und Zylindrizität 0,003mm
- ▶ Lieferung einzeln verpackt

Concentricity test plug gauges ULTRA *active* for BT spindles

- ▶ ISO 7388-2 (JIS 6339 / MAS-BT)
- ▶ Hardened tool steel
- ▶ Concentricity and cylindricity 0.003mm
- ▶ Delivered in individual packages

NEW



No. 1125850

Alle Preise abzüglich Rabatt! / Rabatt anfragen
All prices less discount! / Ask for discount **+49 (0) 6021 42999 00** **-%**

Größe Size	Ø mm	L mm	W kg	Nº	
BT 30	30	250	1,5	1125850	426,00 €
BT 40	40	300	2,6	1125851	435,00 €
BT 50	50	300	4,8	1125852	525,00 €

Rundlaufprüfdorne
ULTRA active
für Morsekegel MK



- ▶ DIN 229
- ▶ Lehenstahl gehärtet
- ▶ Rundlaufgenauigkeit und Zylindrizität 0,003mm
- ▶ Lieferung einzeln verpackt

Concentricity test plug gauges
ULTRA active
for morse tapers (MK)

- ▶ DIN 229
- ▶ Hardened tool steel
- ▶ Concentricity and cylindricity 0.003mm
- ▶ Delivered in individual packages

NEW



No. 1125266

Alle Preise abzüglich Rabatt! / Rabatt anfragen **+49 (0) 6021 42999 00** **-%**
All prices less discount! / Ask for discount

Größe Size	Ø mm	l mm	ḡ kg	Nº	
MK 3	25	250	2,5	1125264	162,00 €
MK 4	32	300	3,5	1125265	207,00 €
MK 5	40	300	5,0	1125266	235,00 €
MK 6	50	500	12,0	1125267	414,00 €

Prüfdorne zwischen Spitzen
ULTRA active



- ▶ Werknorm
- ▶ Lehenstahl gehärtet
- ▶ Rundlaufgenauigkeit und Zylindrizität 0,005mm
- ▶ beide Seiten mit Zentrierung
- ▶ Lieferung einzeln verpackt

Test plug gauges between centres
ULTRA active

- ▶ Works standard
- ▶ Hardened tool steel
- ▶ Concentricity and cylindricity 0.005mm
- ▶ Both sides with centre holes
- ▶ Delivered in individual packages

NEW



No. 1127201

Alle Preise abzüglich Rabatt! / Rabatt anfragen **+49 (0) 6021 42999 00** **-%**
All prices less discount! / Ask for discount

l mm	Ø mm	∠ mm	ḡ kg	Nº	
200	20	0,005	1,0	1127201	126,00 €
300	30	0,005	3,0	1127202	140,00 €
400	40	0,005	8,0	1127203	251,00 €
500	42	0,005	11,0	1127204	270,00 €
750	50	0,005	23,0	1127205	433,00 €

Messsäulen 90°



- ▶ Werknorm
- ▶ aus Spezialstahl gehärtet
- ▶ Standfläche und Mantelfläche bearbeitet
- ▶ mit Handgriff
- ▶ Lieferung einzeln verpackt

Measuring cylinders 90°

- ▶ Works standard
- ▶ Hardened special steel
- ▶ Machined base and jacket surface
- ▶ with handle
- ▶ Delivered in individual packages

PROMO
→ 31.12.2025!

Solange der Vorrat reicht!
While stocks last!



No. 1631103

l mm	Ø mm	l µ	ḡ kg	Nº	Listenpreis Listprice	Aktionspreis Promotion price	% Rabatt Discount
160	60	1	3,5	1631101	406,00 €	366,00 €	
250	80	2	11,0	1631102	623,00 €	560,00 €	
360	100	2	13,0	1631103	1.453,00 €	928,00 €	

% Wichtiger Bestellhinweis % Ihr regulärer Rabatt gilt auch für die bereits reduzierten Aktionspreise!
% Important order notice % Your regular discount also applies to the already reduced promotional prices!

GrenZRachenlehren, doppelmäulig, Sondermaße, Zwischenmaße



- ▶ DIN 2230
- ▶ Lehrenstahl, Messflächen gehärtet
- ▶ Herstellungsgenauigkeit nach DIN EN ISO 286 oder DIN EN ISO 1938-1
- ▶ ISO Toleranzfelder a-zc, Qualität 6-13, alle Zwischenmaße und alle zahlenmäßige Toleranzen
- ▶ Lieferung einzeln verpackt

! Bestellhinweis: bitte das exakte Nennmaß eingeben, z.B. 7,58mm oder 20,495mm, sowie die gewünschte Toleranz z.B. h6 oder +0,01/-0,02mm

Limit snap gauges, double-ended jaws Special sizes, intermediate sizes

- ▶ DIN 2230
- ▶ Tool steel, hardened measuring faces
- ▶ Manufacturing tolerances according to DIN EN ISO 286 or DIN EN ISO 1938-1
- ▶ ISO tolerance a-zc, quality 6-13, all intermediate dimensions and all numerical tolerances
- ▶ Delivered in individual packages

! Order notice: Please enter exact nominal size, e.g. 7.58mm or 0.495mm as well as the required tolerance e.g. h6 oder +0.01/-0.02mm



No. 11401..zm



Alle Preise abzüglich Rabatt! / Rabatt anfragen
All prices less discount! / Ask for discount

+49 (0) 6021 42999 00

-%

mm	mm	kg	Nº	
3,001 – 6,000	0,001	0,06	1140115zm	228,00 €
6,001 – 10,000	0,001	0,06	1140119zm	218,00 €
10,001 – 14,000	0,001	0,08	1140123zm	220,00 €
14,001 – 18,000	0,001	0,1	1140127zm	230,00 €
18,001 – 22,000	0,001	0,12	1140131zm	246,00 €
22,001 – 27,000	0,001	0,15	1140136zm	258,00 €
27,001 – 32,000	0,001	0,15	1140141zm	269,00 €
32,001 – 38,000	0,001	0,2	1140147zm	283,00 €
38,001 – 43,000	0,001	0,29	1140149zm	304,00 €

mm	mm	kg	Nº	
43,001 – 49,000	0,001	0,35	1140154zm	324,00 €
49,001 – 56,000	0,001	0,4	1140157zm	352,00 €
56,001 – 63,000	0,001	0,45	1140160zm	381,00 €
63,001 – 70,000	0,001	0,6	1140163zm	419,00 €
70,001 – 77,000	0,001	0,7	1140166zm	457,00 €
77,001 – 84,000	0,001	0,8	1140168zm	469,00 €
84,001 – 92,000	0,001	0,9	1140172zm	489,00 €
92,001 – 100,000	0,001	0,9	1140175zm	539,00 €

GrenZRachenlehren, Gut- und Ausschussteite in einem Rachen Sondermaße, Zwischenmaße



- ▶ Werksnorm
- ▶ Lehrenstahl, Messflächen gehärtet
- ▶ Herstellungsgenauigkeit nach DIN EN ISO 286 oder DIN EN ISO 1938-1
- ▶ ISO Toleranzfelder a-zc, Qualität 6-13
- ▶ Ab 205mm mit Erleichterungsbohrungen
- ▶ Lieferung einzeln verpackt

! Bestellhinweis: bitte das exakte Nennmaß eingeben, z.B. 120,01mm oder 420,001mm, sowie die gewünschte Toleranz z.B. h6 oder h8

Limit snap gauges, GO and NO-GO sides on one jaw Special sizes, intermediate sizes

- ▶ Works standard
- ▶ Tool steel, hardened measuring faces
- ▶ Manufacturing tolerances according to DIN EN ISO 286 or DIN EN ISO 1938-1
- ▶ ISO tolerance a-zc, quality 6-13
- ▶ From 205mm with relief bores
- ▶ Delivered in individual packages

! Order notice: Please enter exact nominal size, e.g. 120.01mm or 420.001mm as well as the required tolerance e.g. h6 or h8



No. 1150106zm

No. 1150109zm

Alle Preise abzüglich Rabatt! / Rabatt anfragen
All prices less discount! / Ask for discount

+49 (0) 6021 42999 00

-%

mm	mm	kg	Nº	
100,001 - 115,000	0,001	1,5	1150101zm	437,00 €
115,001 - 130,000	0,001	1,65	1150102zm	441,00 €
130,001 - 145,000	0,001	1,95	1150103zm	467,00 €
145,001 - 160,000	0,001	2,1	1150104zm	513,00 €
160,001 - 175,000	0,001	2,34	1150105zm	585,00 €
175,001 - 190,000	0,001	2,55	1150106zm	659,00 €
190,001 - 205,000	0,001	2,89	1150107zm	719,00 €
205,001 - 220,000	0,001	2,6	1150108zm	971,00 €
220,001 - 240,000	0,001	2,8	1150109zm	1.032,00 €
240,001 - 265,000	0,001	2,8	1150110zm	1.108,00 €

mm	mm	kg	Nº	
265,001 - 290,000	0,001	3,3	1150111zm	1.170,00 €
290,001 - 315,000	0,001	3,3	1150112zm	1.224,00 €
315,001 - 340,000	0,001	3,3	1150113zm	1.300,00 €
340,001 - 365,000	0,001	3,6	1150114zm	1.358,00 €
365,001 - 390,000	0,001	4	1150115zm	1.438,00 €
390,001 - 415,000	0,001	4,2	1150116zm	1.534,00 €
415,001 - 445,000	0,001	4,4	1150117zm	1.626,00 €
445,001 - 475,000	0,001	5	1150118zm	1.694,00 €
475,001 - 500,000	0,001	5,5	1150119zm	1.842,00 €

Prüflehren DIN 2253 für Grenzrachenlehren



- ▶ Werksnorm
- ▶ Baumaße nach DIN 2253
- ▶ Lehenstahl, Messflächen gehärtet
- ▶ Herstelltoleranz js3
- ▶ Lieferung einzeln verpackt

I Bestellhinweis: bitte das exakte Nennmaß eingeben, z.B. Ø 1,003mm oder Ø 32,001mm.

11581.. :
bis Ø 40mm vollzylindrische Prüfdorne mit Griff

11582.. :
> Ø 40mm - Ø 100mm vollzylindrische Messscheiben

11583.. :
> Ø 100mm flache Prüfstäbe

Check gauges DIN 2253 for limit snap gauges

- ▶ Works standard
- ▶ Dimensions according to DIN 2253
- ▶ Tool steel, hardened measuring faces
- ▶ Manufacturing tolerance js3
- ▶ Delivered in individual packages

I Order notice: Please enter exact nominal size, e.g. Ø 1.003mm or Ø 32.001mm.

11581.. :
up to Ø 40mm fully cylindrical test plugs with handle

11582.. :
> Ø 40mm - Ø 100mm fully cylindrical discs

11583.. :
> Ø 100mm flat



No. 11582..



No. 11581..



No. 11583..



NEW

> Ø 200 - 450mm siehe Shop
> Ø 200 - 450mm see shop

Alle Preise abzüglich Rabatt! / Rabatt anfragen
All prices less discount! / Ask for discount

+49 (0) 6021 42999 00

-%

Ø mm	mm	Nº	
1,000 - 1,500mm	0,001	1158101	195,00 €
1,501 - 2,000mm	0,001	1158102	105,00 €
2,001 - 3,000mm	0,001	1158103	88,00 €
3,001 - 6,000mm	0,001	1158104	84,50 €
6,001 - 10,000mm	0,001	1158105	84,50 €
10,001 - 14,000mm	0,001	1158106	84,50 €
14,001 - 18,000mm	0,001	1158107	99,00 €
18,001 - 24,000mm	0,001	1158108	107,00 €
24,001 - 30,000mm	0,001	1158109	117,00 €
30,001 - 40,000mm	0,001	1158110	130,00 €

Ø mm	mm	Nº	
40,001 - 50,000mm	0,001	1158201	229,00 €
50,001 - 60,000mm	0,001	1158202	247,00 €
60,001 - 70,000mm	0,001	1158203	283,00 €
70,001 - 80,000mm	0,001	1158204	301,00 €
80,001 - 90,000mm	0,001	1158205	325,00 €
90,001 - 100,000mm	0,001	1158206	350,00 €

Ø mm	mm	Nº	
100,001 - 110,000mm	0,001	1158301	398,00 €
110,001 - 120,000mm	0,001	1158302	408,00 €
120,001 - 130,000mm	0,001	1158303	421,00 €
130,001 - 140,000mm	0,001	1158304	445,00 €
140,001 - 150,000mm	0,001	1158305	461,00 €
150,001 - 160,000mm	0,001	1158306	494,00 €
160,001 - 170,000mm	0,001	1158307	522,00 €
170,001 - 180,000mm	0,001	1158308	550,00 €
180,001 - 190,000mm	0,001	1158309	561,00 €
190,001 - 200,000mm	0,001	1158310	578,00 €

Sonderlehren nach Zeichnung



- ▶ Wir liefern jede Art von Sonderlehren gemäß Ihren Zeichnungen.
- ▶ Zum Beispiel Abstecklehren, Mittigkeitslehren, Konturlehren, Profillehren, Tiefenlehren, Lochbildlehren, Überstandslehren, Stufenlehren, Einstellmeister, Eichmeister usw.
- ▶ Auf Wunsch auch mit Werkskalibrierschein gegen Berechnung.
- ▶ Konzeption und Konstruktion sind gegen Aufpreis möglich.
- ▶ Sehr komplexe Messaufgaben sind für uns kein Problem - das ULTRA-Vertriebsteam berät Sie gerne und findet schnell die passende Lösung.
- ▶ Zur Angebotserstellung bitten wir um Ihre Anfragen mit Zeichnungsunterlagen.

Special gauges according drawing

- ▶ We supply all types of special gauges according to your drawings.
- ▶ For example position gauges, centre gauges, contour gauges, profile gauges, depth gauges, hole pattern gauges, step gauges, setting masters, calibration masters etc.
- ▶ Works calibration certificates on request at extra charge.
- ▶ Conception and design are possible at cost.
- ▶ Difficult measuring tasks are no problem for us - the ULTRA-sales team helps you to find a quick and suitable solution.
- ▶ For the preparation of a quotation, please send your inquiries with drawings.

Beispiele für Sonderlehren:
Examples for special gauges:

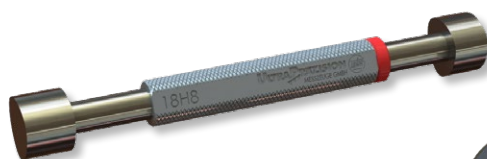

Polygonlehrdorn
Polygon plug gauge



Polygonlehrring
Polygon ring gauge



Mittigkeitslehre
Centre gauge

Anzeigende Rachenlehren MINI APOLLO MD CARBON mit planen Messflächen



- ▶ Werksnorm
- ▶ Hartmetallmessflächen Ø 8,5mm
- ▶ Griff aus Kohlefaser, Bügel aus rostfreiem Stahl
- ▶ extrem geringes Gewicht, hohe Formstabilität
- ▶ Freihub 2mm, mit Handhebel
- ▶ konstante Messkraft
- ▶ Wiederholgenauigkeit ±0,001mm
- ▶ verstellbare Auflage für die Positionierung des Werkstücks
- ▶ Messuhraufnahme Ø 8mm
- ▶ Lieferung im Etui ohne Messuhr

Indicating dial snap gauges MINI APOLLO MD CARBON with plane measuring surfaces

- ▶ Works standard
- ▶ Tungsten carbide measuring contacts Ø 8.5mm
- ▶ Carbon fibre handle, stainless steel frame
- ▶ Extremely low weight, high strength of shape
- ▶ Free lift 2mm, with hand lever
- ▶ Constant measuring force
- ▶ Repeatability ±0.001mm
- ▶ Adjustable support for positioning of the work piece
- ▶ Dial mounting hole Ø 8mm
- ▶ Delivered in a case without dial gauge



No. 115930.

NEW

Shop

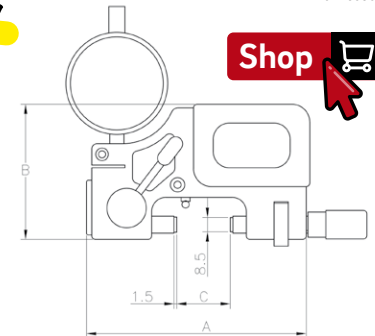

Alle Preise abzüglich Rabatt! / Rabatt anfragen
All prices less discount! / Ask for discount

+49 (0) 6021 42999 00

-%

C mm	A mm	B mm	kg	Nº DEMM	Nº	
0 – 30	123	76	0,45	01015	1159301	1.050,00 €
30 – 60	153	94	0,55	01016	1159302	1.428,00 €
60 – 100	193	114	0,65	01017	1159303	1.596,00 €

Anzeigende Rachenlehren MINI APOLLO PI CARBON mit auswechselbaren Messeinsätzen



- ▶ Werksnorm
- ▶ Messeinsätze auswechselbar mit Einspannschaft Ø 3,5mm
- ▶ Griff aus Kohlefaser, Bügel aus rostfreiem Stahl
- ▶ extrem geringes Gewicht, hohe Formstabilität
- ▶ Freihub 2mm, mit Handhebel
- ▶ konstante Messkraft
- ▶ Wiederholgenauigkeit ±0,001mm
- ▶ verstellbare Auflage für die Positionierung des Werkstücks
- ▶ Messuhraufnahme Ø 8mm
- ▶ Lieferung im Etui ohne Messuhr, inkl. Kugelmesseinsätze Ø 3mm

Indicating dial snap gauges MINI APOLLO PI CARBON with interchangeable measuring inserts

- ▶ Works standard
- ▶ Interchangeable measuring inserts with shaft Ø 3.5mm
- ▶ Carbon fibre handle, stainless steel frame
- ▶ Extremely low weight, high strength of shape
- ▶ Free lift 2mm, with hand lever
- ▶ Constant measuring force
- ▶ Repeatability ±0.001mm
- ▶ Adjustable support for positioning of the work piece
- ▶ Dial mounting hole Ø 8mm
- ▶ Delivered in a case without dial gauge, incl. ball measuring inserts Ø 3mm



No. 115940.

NEW

Messeinsätze auswechselbar Schaft Ø3,5
Measuring inserts interchangeable shaft Ø3.5

Alle Preise abzüglich Rabatt! / Rabatt anfragen
All prices less discount! / Ask for discount

+49 (0) 6021 42999 00

-%

C mm	A mm	B mm	kg	Nº DEMM	Nº	
0 – 25	123	76	0,45	01018	1159401	1.260,00 €
25 – 50	153	94	0,55	01019	1159402	1.638,00 €
50 – 90	193	114	0,65	01020	1159403	1.806,00 €

Shop

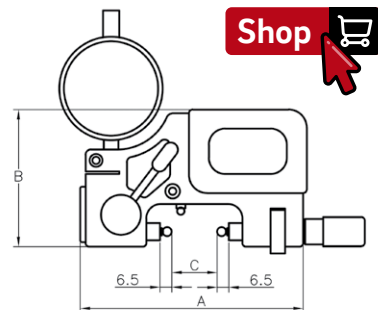

Anzeigende Rachenlehren
APOLLO CARBON



- ▶ Werksnorm
- ▶ Messeinsätze auswechselbar mit Einspannschaft Ø 3,5mm
- ▶ Bügel aus Kohlefaser
- ▶ extrem geringes Gewicht, hohe Formstabilität
- ▶ Zentrierstütze und Abhebevorrichtung
- ▶ Freihub 5mm
- ▶ konstante Messkraft
- ▶ Wiederholgenauigkeit mit Kugeleinsatz ±0,001mm
- ▶ Messuhraufnahme Ø 8mm
- ▶ Lieferung im Etui ohne Messuhr, mit Kugelmesseinsätze Ø 3mm

Indicating dial snap gauges
APOLLO CARBON

- ▶ Works standard
- ▶ Interchangeable measuring inserts with shaft Ø 3.5mm
- ▶ Carbon fibre frame
- ▶ Extremely low weight, high strength of shape
- ▶ Centre supports and lifting device
- ▶ Free lift 5mm
- ▶ Constant measuring force
- ▶ Repeatability with ball inserts ±0.001mm
- ▶ Dial mounting hole Ø 8mm
- ▶ Delivered in a case without dial gauge, with ball measuring inserts Ø 3mm

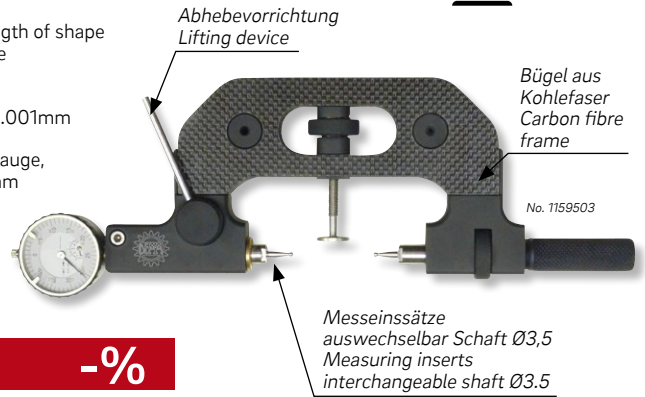

Alle Preise abzüglich Rabatt! / Rabatt anfragen
All prices less discount! / Ask for discount

+49 (0) 6021 42999 00

-%

A mm	B mm	C mm	D mm	E mm	kg	Nº DEMM	Nº	
0 – 50	247	95	66	97	0,42	00800	1159501	1.270,00 €
50 – 100	297	124	66	97	0,5	00801	1159502	1.355,00 €
100 – 150	347	150	66	97	0,62	00802	1159503	1.417,00 €
150 – 200	397	174	66	97	0,72	00803	1159504	1.576,00 €
200 – 250	447	210	66	97	0,92	00804	1159505	1.904,00 €
250 – 300	497	234	66	97	1,02	00805	1159506	2.307,00 €
300 – 350	547	260	66	97	1,5	00806	1159507	2.697,00 €
350 – 400	597	284	66	97	2	00807	1159508	3.438,00 €
400 – 450	647	310	66	97	2,3	00812	1159509	4.188,00 €
450 – 500	707	374	66	97	2,6	00808	1159509x	4.653,00 €
500 – 600	960	437	95	230	4	00809	1159510	5.235,00 €
600 – 700	1010	487	95	230	4,8	00810	1159511	6.134,00 €
700 – 800	1060	537	95	230	5,5	00811	1159512	6.610,00 €

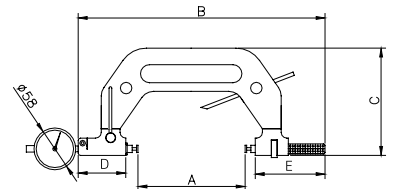

Messeinsätze, Paar für Rachenlehren
MINI APOLLO PI und APOLLO



- ▶ Spezialstahl gehärtet
- ▶ Passend für alle DEMM-Vergleichsmessgeräte, Rachenlehren, QUICK CHECK etc. mit Einspannschaft Ø 3,5mm
- ▶ Lieferung als Paar einzeln verpackt

Measuring inserts, pair for snap gauges
MINI APOLLO PI and APOLLO

- ▶ Special steel hardened
- ▶ Usable for all DEMM comparative measuring instruments, snap gauges, QUICK CHECK etc. with shaft Ø 3.5mm
- ▶ Delivered as pair in individual packages



Alle Preise abzüglich Rabatt! / Rabatt anfragen
All prices less discount! / Ask for discount

+49 (0) 6021 42999 00

-%

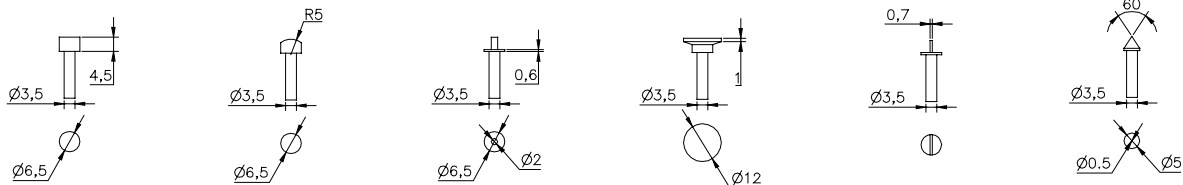

Nº DEMM	03020	03021	03022	03023	03024	03025
Nº	1159901 150,00€	1159902 150,00€	1159903 150,00€	1159904 176,00€	1159905 150,00€	1159906 150,00€

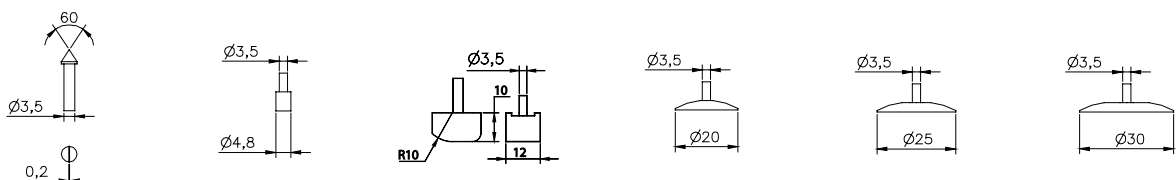

Nº DEMM	03026	03030	03031	03032	03033	03034
Nº	1159907 150,00€	1159908 150,00€	1159909 186,00€	1159910 218,00€	1159911 244,00€	1159912 244,00€

Digital-Bügelmessschrauben IP65 ULTRA *active*



- ▶ DIN 863
- ▶ Schutzart IP65
- ▶ großes LCD Display
- ▶ Hartmetallmessflächen Ø6,5mm
- ▶ Spindelsteigung 0,5mm
- ▶ Spindelklemmung mit Hebel
- ▶ Gefühlsratsche
- ▶ Messkraft 5 – 10 N
- ▶ Handwärmeschutz
- ▶ Batterie CR 2032 3V
- ▶ Lieferung im Etui, ab 25 – 50mm mit Einstellmaß

Funktionen:

- ▶ Ein/Aus, mm/inch Umschaltung, 0-Punkt an jeder Position, Preset Funktion ±, ABS-Funktion, Datenausgang DIGIMATIC

Digital external micrometers IP65 ULTRA *active*

- ▶ DIN 863
- ▶ Protection class IP65
- ▶ Large LCD display
- ▶ Tungsten carbide-tipped measuring faces Ø6.5mm
- ▶ Spindle pitch 0.5mm
- ▶ Spindle clamping with lever
- ▶ Ratchet stop
- ▶ Measuring force 5 – 10 N
- ▶ Insulated pads
- ▶ Battery CR 2032 3V
- ▶ Delivered in a case; from 25 – 50mm with setting gauge

Functions:

- ▶ On/Off, mm/inch commutation, Zero setting at any position, Preset function ±, ABS function, Data output DIGIMATIC

**AB LAGER!
EX STOCK!**



Alle Preise abzüglich Rabatt! / Rabatt anfragen
All prices less discount! / Ask for discount **+49 (0) 6021 42999 00**

-%

mm	inch approx.	mm	inch	kg	Nº	mm	inch approx.	mm	inch	kg	Nº
0 – 25	0 – 1	0,001	.00005	0,44	6200101 127,00 €	75 – 100	3 – 4	0,001	.00005	1,18	6200104 183,00 €
25 – 50	1 – 2	0,001	.00005	0,62	6200102 155,00 €	100 – 125	4 – 5	0,001	.00005	1,44	6200105 218,00 €
50 – 75	2 – 3	0,001	.00005	0,78	6200103 176,00 €	125 – 150	5 – 6	0,001	.00005	1,74	6200106 244,00 €

Digital-Bügelmessschrauben ULTRA *active*



- ▶ DIN 863
- ▶ großes LCD Display
- ▶ Hartmetallmessflächen Ø6,5mm
- ▶ Spindelsteigung 0,5mm
- ▶ Spindelklemmung mit Rad
- ▶ Gefühlsratsche
- ▶ Batterie CR 2032 3V
- ▶ Lieferung im Etui, inklusive Einstellmaß

Funktionen:

- ▶ Ein/Aus, mm/inch Umschaltung, 0-Punkt an jeder Position, Preset Funktion ±, ABS/INC-Funktion

Digital external micrometers ULTRA *active*

- ▶ DIN 863
- ▶ Large LCD display
- ▶ Tungsten carbide-tipped measuring faces Ø6.5mm
- ▶ Spindle pitch 0.5mm
- ▶ Spindle clamping with wheel
- ▶ Ratchet stop
- ▶ Battery CR 2032 3V
- ▶ Delivered in a case, including setting gauge

Functions:

- ▶ On/Off, mm/inch commutation, Zero setting at any position, Preset function ±, ABS/INC function

NEW



Alle Preise abzüglich Rabatt! / Rabatt anfragen
All prices less discount! / Ask for discount **+49 (0) 6021 42999 00**

-%

mm	inch approx.	mm	inch	kg	Nº	mm	inch approx.	mm	inch	kg	Nº
150 – 175	6 – 7	0,001	.00005	1,6	6200201 298,00 €	225 – 250	9 – 10	0,001	.00005	2,3	6200204 384,00 €
175 – 200	7 – 8	0,001	.00005	1,7	6200202 326,00 €	250 – 275	10 – 11	0,001	.00005	2,4	6200205 413,00 €
200 – 225	8 – 9	0,001	.00005	1,8	6200203 355,00 €	275 – 300	11 – 12	0,001	.00005	2,5	6200206 442,00 €

Digital-Bügelmessschrauben
ULTRA active
mit auswechselbaren Einsätzen



- ▶ Werksnorm
- ▶ großes LCD Display
- ▶ Hartmetallmessflächen Ø8mm
- ▶ Messtrommel mattverchromt Ø16mm
- ▶ Spindelsteigung 0,5mm
- ▶ Spindelklemmung mit Rad
- ▶ Gefühlsratsche
- ▶ Ab 300mm mit Handwärmeschutz
- ▶ Batterie LR44
- ▶ Lieferung im Etui, inklusive Einstellmaß

Funktionen:

- ▶ Ein/Aus, mm/inch Umschaltung, 0-Punkt an jeder Position, ABS/INC-Funktion

Digital external micrometers
ULTRA active
with interchangeable inserts

- ▶ Works standard
- ▶ Large LCD display
- ▶ Tungsten carbide-tipped measuring faces Ø8mm
- ▶ Measuring drum matt Ø16mm
- ▶ Spindle pitch 0.5mm
- ▶ Spindle clamping with wheel
- ▶ Ratchet stop
- ▶ From 300mm with insulated pads
- ▶ Battery LR44
- ▶ Delivered in a case, including setting gauge

Functions:

- ▶ On/Off, mm/inch commutation, Zero setting at any position, ABS/INC function



Alle Preise abzüglich Rabatt! / Rabatt anfragen
All prices less discount! / Ask for discount

+49 (0) 6021 42999 00

-%

mm	inch approx.	mm	inch	mm	Einstellmaße Setting gauges mm	kg	Nº	
0 – 150	0 – 6	0,001	.00005	0,011	25 / 50 / 75 / 100 / 125	1,8	6200301	348,00 €
150 – 300	6 – 12	0,001	.00005	0,013	150–275 / Stufung / Step 25	3,1	6200302	367,00 €
300 – 400	12 – 16	0,001	.00005	0,013	325/375	4,3	6200303	388,00 €
400 – 500	16 – 20	0,001	.00005	0,013	425/475	7	6200304	448,00 €
500 – 600	20 – 24	0,001	.00005	0,015	525/575	10	6200305	508,00 €

Bügelmessschrauben
ULTRA active
mit auswechselbaren Einsätzen



- ▶ DIN 863
- ▶ Ableseteile mattverchromt
- ▶ Hartmetallmessflächen
- ▶ Spindelsteigung 0,5mm (No. 5013215 und 5013216 = 1,0mm)
- ▶ Spindelklemmung mit Hebel
- ▶ Gefühlsratsche
- ▶ Lieferung im Etui mit Einstellmaßen

External micrometers
ULTRA active
with interchangeable inserts

- ▶ DIN 863
- ▶ Satin chrome reading parts
- ▶ Tungsten carbide-tipped measuring faces
- ▶ Spindle pitch 0.5mm (No. 5013215 and 5013216 = 1.0mm)
- ▶ Spindle clamping with lever
- ▶ Ratchet stop
- ▶ Delivered in a case with setting gauges



Alle Preise abzüglich Rabatt! / Rabatt anfragen
All prices less discount! / Ask for discount

+49 (0) 6021 42999 00

-%

mm	mm	Einstellmaße Setting gauges mm	kg	Nº		mm	mm	Einstellmaße Setting gauges mm	kg	Nº	
600 - 700	0,01	625 / 675	10,5	5013208	565,00 €	1200 - 1400	0,01	1250 / 1350	33	5013213	2.147,00 €
700 - 800	0,01	725 / 775	14	5013209	665,00 €	1400 - 1600	0,01	1450 / 1550	40	5013214	2.511,00 €
800 - 900	0,01	825 / 875	16,5	5013210	837,00 €	1600 - 1800	0,01	1650 / 1750	50	5013215	3.045,00 €
900 - 1000	0,01	925 / 975	20	5013211	912,00 €	1800 - 2000	0,01	1850 / 1950	60	5013216	3.502,00 €
1000 - 1200	0,01	1025 / 1075	29	5013212	1.898,00 €						

Digital-Innen-Schnellmessgeräte XTH mit Bluetooth-Funktion

Digital pistol grip bore gauges XTH with Bluetooth function



- ▶ DIN 863
- ▶ Schutzart IP67, Sylvac System
- ▶ Hartmetallmessflächen (< 12,5mm mit Stahlmessflächen gehärtet)
- ▶ Pistolengriff
- ▶ großes LCD Display
- ▶ mit Bluetooth-Funktion und SylvacBT Smart App zur kabellosen Datenübertragung
- ▶ konstante Messkraft, federbelastet
- ▶ Lieferung im Etui, inklusive Einstellring und UKAS-Kalibrierschein

Funktionen:

- ▶ Ein/Aus
- ▶ mm/inch Umschaltung
- ▶ 0-Punkt an jeder Position
- ▶ Preset Funktion ±
- ▶ max. / min. Wertspeicher
- ▶ Hold Funktion
- ▶ Datenausgang Proximity

- ▶ DIN 863
- ▶ Protection class IP67, Sylvac System
- ▶ Tungsten carbide-tipped measuring faces (< 12.5mm with steel measuring faces hardened)
- ▶ Pistol handle
- ▶ Large LCD display
- ▶ With Bluetooth function and SylvacBT Smart App for a wireless data transmission
- ▶ Constant measuring force, spring loaded
- ▶ Delivered in a case, inclusive setting rings and UKAS calibration certificate

Functions:

- ▶ On/Off
- ▶ mm/inch commutation
- ▶ Zero setting at any position
- ▶ Preset function ±
- ▶ Max. / min. memory
- ▶ Hold function
- ▶ Data output Proximity



**AB LAGER!
EX STOCK!**



Alle Preise abzüglich Rabatt! / Rabatt anfragen
All prices less discount! / Ask for discount

+49 (0) 6021 42999 00

-%

mm	inch approx.	mm	inch	mm	A mm	Taster/ Probe	↓ N	mm	kg	Nº BOWERS	Nº	
2 - 2,5	.08 - .10	0,001	0,0005	9	0	2-P	10 - 7	0,004	1,7	XTH1M-BT	2510196b	2.099,00 €
2,5 - 3	.10 - .12	0,001	0,0005	9	0	2-P	10 - 7	0,004	1,7	XTH2M-BT	2510197b	2.099,00 €
3 - 4	.12 - .16	0,001	0,0005	12	0	2-P	10 - 7	0,004	1,7	XTH3M-BT	2510198b	2.099,00 €
4 - 5	.16 - .20	0,001	0,0005	18	0	2-P	10 - 7	0,004	1,9	XTH4M-BT	2510199b	2.099,00 €
5 - 6	.20 - .25	0,001	0,0005	18	0	2-P	10 - 7	0,004	1,9	XTH5M-BT	2510200b	2.099,00 €
6 - 8	.25 - .3	0,001	.00005	58	1,6	3-P	18 - 8	0,004	0,3	XTH6M-BT	2510201b	1.503,00 €
8 - 10	.3 - .4	0,001	.00005	58	1,6	3-P	18 - 8	0,004	0,3	XTH8M-BT	2510202b	1.472,00 €
10 - 12,5	.4 - .5	0,001	.00005	58	1,9	3-P	18 - 8	0,004	0,3	XTH10M-BT	2510203b	1.449,00 €
12,5 - 16	.5 - .6	0,001	.00005	62	0,5	3-P	18 - 8	0,004	0,3	XTH12M-BT	2510204b	1.467,00 €
16 - 20	.6 - .8	0,001	.00005	62	0,5	3-P	18 - 8	0,004	0,5	XTH16M-BT	2510205b	1.554,00 €
20 - 25	.8 - 1	0,001	.00005	66	0,5	3-P	35 - 15	0,004	0,5	XTH20M-BT	2510206b	1.690,00 €
25 - 35	1 - 1.37	0,001	.00005	66	0,5	3-P	35 - 15	0,004	0,5	XTH25M-BT	2510207b	1.745,00 €
35 - 50	1.37 - 2	0,001	.00005	80	0,5	3-P	35 - 15	0,004	1,1	XTH35M-BT	2510208b	1.788,00 €
50 - 65	2 - 2.55	0,001	.00005	80	0,5	3-P	35 - 15	0,005	1,1	XTH50M-BT	2510209b	1.969,00 €
65 - 80	2.55 - 3.15	0,001	.00005	80	0,5	3-P	35 - 15	0,005	1,1	XTH65M-BT	2510210b	1.969,00 €
80 - 100	3.15 - 4	0,001	.00005	100	0,5	3-P	35 - 15	0,005	1,2	XTH80M-BT	2510211b	2.093,00 €
100 - 125	4 - 5	0,001	.00005	115	0,5	3-P	40 - 15	0,006	2,1	XTH100M-BT	2510212b	2.238,00 €
125 - 150	5 - 6	0,001	.00005	115	0,5	3-P	40 - 15	0,006	2,7	XTH125M-BT	2510213b	2.367,00 €
150 - 175	6 - 7	0,001	.00005	115	0,5	3-P	40 - 15	0,007	3,5	XTH150M-BT	2510214b	2.503,00 €
175 - 200	7 - 8	0,001	.00005	115	0,5	3-P	40 - 15	0,007	3,8	XTH175M-BT	2510215b	2.614,00 €
200 - 225	8 - 9	0,001	.00005	118	0,5	3-P	40 - 15	0,008	3,8	XTH200M-BT	2510216b	3.415,00 €
225 - 250	9 - 10	0,001	.00005	118	0,5	3-P	40 - 15	0,008	3,8	XTH225M-BT	2510217b	3.765,00 €
250 - 275	10 - 11	0,001	.00005	118	0,5	3-P	40 - 15	0,009	3,8	XTH250M-BT	2510218b	3.897,00 €
275 - 300	11 - 12	0,001	.00005	118	0,5	3-P	40 - 15	0,009	3,8	XTH275M-BT	2510219b	4.290,00 €
Sätze / Sets												
2 - 6	.08 - .25	0,001	.00005	9 / 12 / 18	-	2-P	10 - 7	0,004	2,0	SXTH1M-BT	2510500b	4.722,00 €
6 - 10	.25 - .4	0,001	.00005	58	1,6	3-P	18 - 8	0,004	1,3	SXTH3M-BT	2510501b	1.736,00 €
10 - 20	.4 - .8	0,001	.00005	58 / 62	1,9 / 0,5	3-P	18 - 8	0,004	2,0	SXTH4M-BT	2510502b	2.037,00 €
20 - 50	.8 - 2	0,001	.00005	66 / 80	0,5	3-P	35 - 15	0,004	3,6	SXTH5M-BT	2510503b	2.523,00 €
50 - 100	2 - 4	0,001	.00005	80 / 100	0,5	3-P	35 - 15	0,005	5,28	SXTH6M-BT	2510504b	2.955,00 €
100 - 150	4 - 6	0,001	.00005	115	0,5	3-P	40 - 15	0,006	7,2	SXTH7M-BT	2510505b	2.771,00 €
150 - 200	6 - 8	0,001	.00005	115	0,5	3-P	40 - 15	0,007	12,0	SXTH8M-BT	2510506b	3.679,00 €
Große Sätze / Large sets												
6 - 20	.25 - .8	0,001	.00005	58 / 62	1,6 / 1,9 / 0,5	3-P	18 - 8	0,004	2,7	SXTH10M-BT	2510507b	2.554,00 €
20 - 100	.8 - 4	0,001	.00005	66 / 80 / 100	0,5	3-P	35 - 15	0,004 / 0,005	8,4	SXTH11M-BT	2510508b	4.551,00 €
100 - 200	4 - 8	0,001	.00005	115	0,5	3-P	40 - 15	0,006 / 0,007	18,0	SXTH9M-BT	2510509b	5.599,00 €

Digital-Innenmessschrauben XTD mit Bluetooth-Funktion

Digital internal micrometers XTD with Bluetooth function



- ▶ DIN 863
- ▶ Schutzart IP67, Sylvac System
- ▶ Hartmetallmessflächen (< 12,5mm mit Stahlmessflächen gehärtet)
- ▶ großes LCD Display
- ▶ mit Bluetooth-Funktion und SylvacBT Smart App zur kabellosen Datenübertragung
- ▶ kräftige Ratsche
- ▶ Lieferung im Etui inklusive Einstellringe und UKAS-Kalibrierschein

Funktionen:

- ▶ Ein/Aus
- ▶ mm/inch Umschaltung
- ▶ 0-Punkt an jeder Position
- ▶ Preset Funktion ±
- ▶ max. / min. Wertspeicher
- ▶ Hold Funktion
- ▶ Datenausgang Proximity

- ▶ DIN 863
- ▶ Protection class IP67, Sylvac System
- ▶ Tungsten carbide-tipped measuring faces (< 12.5mm with steel measuring faces hardened)
- ▶ Large LCD display
- ▶ With Bluetooth function and SylvacBT Smart App for a wireless data transmission
- ▶ Sturdy ratchet
- ▶ Delivered in a case inclusive settings rings and UKAS calibration certificate

Functions:

- ▶ On/Off
- ▶ mm/inch commutation
- ▶ Zero setting at any position
- ▶ Preset function ±
- ▶ Max. / min. memory
- ▶ Hold function
- ▶ Data output Proximity



No. 2502203b



**AB LAGER!
EX STOCK!**





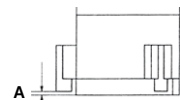



No. 2502113b



Alle Preise abzüglich Rabatt! / Rabatt anfragen  +49 (0) 6021 42999 00

All prices less discount! / Ask for discount

-%

mm	 inch approx.	mm	 inch	 mm	A mm	Taster / Probe	 N	 mm	 kg	N ^o BOWERS	N ^o	
2 – 2,5	.08 – .10	0,001	0,0005	9	0	2-P	29 – 19	0,004	1	XTD1M-BT	2501096b	1.833,00 €
2,5 – 3	.10 – .12	0,001	0,0005	9	0	2-P	29 – 19	0,004	1	XTD2M-BT	2501097b	1.833,00 €
3 – 4	.12 – .16	0,001	0,0005	12	0	2-P	29 – 19	0,004	1	XTD3M-BT	2501098b	1.833,00 €
4 – 5	.16 – .20	0,001	0,0005	18	0	2-P	29 – 19	0,004	1	XTD4M-BT	2501099b	1.833,00 €
5 – 6	.20 – .25	0,001	0,0005	18	0	2-P	29 – 19	0,004	1	XTD5M-BT	2501100b	1.833,00 €
6 – 8	.25 – .3	0,001	.00005	58	1,6	3-P	23 – 14	0,004	0,3	XTD6M-BT	2501101b	1.200,00 €
8 – 10	.3 – .4	0,001	.00005	58	1,6	3-P	23 – 14	0,004	0,3	XTD8M-BT	2501102b	1.200,00 €
10 – 12,5	.4 – .5	0,001	.00005	58	1,9	3-P	29 – 15	0,004	0,3	XTD10M-BT	2501103b	1.217,00 €
12,5 – 16	.5 – .6	0,001	.00005	62	0,5	3-P	29 – 15	0,004	0,3	XTD12M-BT	2502104b	1.230,00 €
16 – 20	.6 – .8	0,001	.00005	62	0,5	3-P	29 – 15	0,004	0,5	XTD16M-BT	2502106b	1.230,00 €
20 – 25	.8 – 1	0,001	.00005	66	0,5	3-P	32 – 15	0,004	0,5	XTD20M-BT	2502107b	1.496,00 €
25 – 35	1 – 1.37	0,001	.00005	66	0,5	3-P	32 – 15	0,004	0,5	XTD25M-BT	2502109b	1.712,00 €
35 – 50	1.37 – 2	0,001	.00005	80	0,5	3-P	32 – 15	0,004	1,1	XTD35M-BT	2502111b	1.773,00 €
50 – 65	2 – 2.55	0,001	.00005	80	0,5	3-P	47 – 32	0,005	1,1	XTD50M-BT	2502113b	1.974,00 €
65 – 80	2.55 – 3.15	0,001	.00005	80	0,5	3-P	47 – 32	0,005	1,1	XTD65M-BT	2502114b	1.974,00 €
80 – 100	3.15 – 4	0,001	.00005	100	0,5	3-P	47 – 32	0,005	1,2	XTD80M-BT	2502115b	2.078,00 €
100 – 125	4 – 5	0,001	.00005	115	0,5	3-P	55 – 35	0,006	2,1	XTD100M-BT	2502116b	2.113,00 €
125 – 150	5 – 6	0,001	.00005	115	0,5	3-P	55 – 35	0,006	2,7	XTD125M-BT	2502117b	2.180,00 €
150 – 175	6 – 7	0,001	.00005	115	0,5	3-P	55 – 35	0,007	3,5	XTD150M-BT	2502118b	2.545,00 €
175 – 200	7 – 8	0,001	.00005	115	0,5	3-P	55 – 35	0,007	3,8	XTD175M-BT	2502119b	2.703,00 €
200 – 225	8 – 9	0,001	.00005	118	0,5	3-P	62 – 47	0,008	3,8	XTD200M-BT	2502120b	3.260,00 €
225 – 250	9 – 10	0,001	.00005	118	0,5	3-P	62 – 47	0,008	3,8	XTD225M-BT	2502121b	3.585,00 €
250 – 275	10 – 11	0,001	.00005	118	0,5	3-P	62 – 47	0,009	3,8	XTD250M-BT	2502122b	3.714,00 €
275 – 300	11 – 12	0,001	.00005	118	0,5	3-P	62 – 47	0,009	3,8	XTD275M-BT	2502123b	4.129,00 €

Sätze / Sets

2 – 6	.08 – .25	0,001	.00005	9 / 12 / 18	–	2-P	29 – 19	0,004	2,0	SXTD1M-BT	2501200b	4.107,00 €
6 – 10	.25 – .4	0,001	.00005	58	1,6	3-P	23 – 14	0,004	2,0	SXTD3M-BT	2502201b	1.676,00 €
10 – 20	.4 – .8	0,001	.00005	58 / 62	1,9 / 0,5	3-P	29 – 15	0,004	2,0	SXTD4M-BT	2502202b	2.012,00 €
20 – 50	.8 – 2	0,001	.00005	66 / 80	0,5	3-P	32 – 15	0,004	3,2	SXTD5M-BT	2502203b	2.745,00 €
50 – 100	2 – 4	0,001	.00005	80 / 100	0,5	3-P	47 – 32	0,005	5,0	SXTD6M-BT	2502204b	2.910,00 €
100 – 150	4 – 6	0,001	.00005	115	0,5	3-P	55 – 35	0,006	7,0	SXTD7M-BT	2502205b	2.690,00 €
150 – 200	6 – 8	0,001	.00005	115	0,5	3-P	55 – 35	0,007	12,0	SXTD8M-BT	2502206b	3.574,00 €
100 – 200	4 – 8	0,001	.00005	115	0,5	3-P	55 – 35	0,006 / 0,007	18,5	SXTD9M-BT	2502207b	5.430,00 €

Digital-Innenmessschrauben-Sätze XTD-MULTI mit zusätzlichen Ableseeinheiten

Digital internal micrometer sets XTD-MULTI with additional readout units



- ▶ DIN 863
- ▶ Schutzart IP67, Sylvac System
- ▶ Hartmetallmessflächen (< 12,5mm mit Stahlmessflächen gehärtet)
- ▶ großes LCD Display
- ▶ mit Bluetooth-Funktion und SylvacBT Smart App zur kabellosen Datenübertragung
- ▶ kräftige Ratsche
- ▶ Alle Ableseeinheiten passend zu den Messköpfen kalibriert
- ▶ Lieferung im Etui, inklusive Einstellringe und UKAS-Kalibrierschein

Funktionen:

- ▶ Ein/Aus
- ▶ mm/inch Umschaltung
- ▶ 0-Punkt an jeder Position
- ▶ Preset Funktion ±
- ▶ max. / min. Wertspeicher
- ▶ Hold Funktion
- ▶ Datenausgang Proximity



- ▶ DIN 863
- ▶ Protection class IP67, Sylvac System
- ▶ Tungsten carbide-tipped measuring faces (< 12.5mm with steel measuring faces hardened)
- ▶ Large LCD display
- ▶ With Bluetooth function and SylvacBT Smart App for a wireless data transmission
- ▶ Sturdy ratchet
- ▶ All reading units calibrated to match the measuring heads
- ▶ Delivered in a case, including setting rings and UKAS calibration certificate

Funktionen:

- ▶ On/Off
- ▶ mm/inch commutation
- ▶ Zero setting at any position
- ▶ Preset function ±
- ▶ Max. / min. memory
- ▶ Hold function
- ▶ Data output Proximity

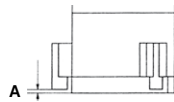

No. 2502303b



Alle Preise abzüglich Rabatt! / Rabatt anfragen +49 (0) 6021 42999 00

-%

mm	inch approx.	mm	inch	mm	A mm	Ableseeinheiten / Readout units	N	mm	kg	Nº BOWERS	Nº	
6 - 10	.25 - .4	0,001	0,0005	58	1,6	2	23 - 14	0,004	3	SXTD3U-BT	2502301b	2.439,00 €
10 - 20	.4 - .8	0,001	0,0005	58 / 62	1,9 / 0,5	3	29 - 15	0,004	4	SXTD4U-BT	2502302b	3.697,00 €
20 - 50	.8 - 2	0,001	0,0005	66 / 80	0,5	3	32 - 15	0,004	5,2	SXTD5U-BT	2502303b	4.869,00 €
50 - 100	2 - 4	0,001	0,0005	80 / 100	0,5	3	47 - 32	0,005	7	SXTD6U-BT	2502304b	5.036,00 €

💡 Wussten Sie schon? Did you know?

XT THREAD für Gewindemessung und XT GROOVE für Nutenmessung

Sie haben einen speziellen Anwendungsfall? Wir liefern auch XTH Geräte zum Messen von Verzahnungen, Einstichen, sphärischen Werkstücken, Sonder-Gewinden, große Messtiefen und vieles mehr.

Bitte senden Sie uns Ihre Anfrage mit Zeichnungen an info@ultra-germany.com.

XT THREAD for thread measuring and XT GROOVE for groove measuring

Are you looking to solve another measuring task? We also deliver XTH devices for measuring splines, recesses, sphericals, special threads, long measuring depths and much more.

Please send us your inquiry with drawings to info@ultra-germany.com.



Innenmessschrauben XTA



- ▶ DIN 863
- ▶ Ableseteile mattverchromt
- ▶ bei Messbereichen < 20mm wird XTA MICRO geliefert
- ▶ Hartmetallmessflächen (< 12,5mm mit Stahlmessflächen gehärtet)
- ▶ Spindelsteigung 0,5mm
- ▶ kräftige Ratsche
- ▶ Lieferung im Etui inkl. Einstellringe und UKAS-Kalibrierschein

Internal micrometers XTA

- ▶ DIN 863
- ▶ Satin chrome reading parts
- ▶ For measuring ranges < 20mm XTA MICRO will be delivered
- ▶ Tungsten carbide-tipped measuring faces (< 12.5mm with steel measuring faces hardened)
- ▶ Spindle pitch 0.5mm
- ▶ Sturdy ratchet
- ▶ Delivered in a case incl. setting rings and UKAS calibration certificate

**AB LAGER!
EX STOCK!**



Alle Preise abzüglich Rabatt! / Rabatt anfragen
All prices less discount! / Ask for discount

+49 (0) 6021 42999 00

-%

mm	\leq mm	mm	A mm	Taster Probes	mm	mm	kg	Nº BOWERS	Nº	
2 – 2,5	0,001	9	-	2-P	18 – 12	0,004	0,5	MXTA1M	2094096	950,00 €
2,5 – 3	0,001	9	-	2-P	18 – 12	0,004	0,5	MXTA2M	2094097	950,00 €
3 – 4	0,001	12	-	2-P	18 – 12	0,004	0,5	MXTA3M	2094098	849,00 €
4 – 5	0,001	18	-	2-P	18 – 12	0,004	0,5	MXTA4M	2094099	849,00 €
5 – 6	0,001	18	-	2-P	18 – 12	0,004	0,6	MXTA5M	2094100	849,00 €
6 – 8	0,002	58	1,6	3-P	25 – 14	0,004	0,3	MXTA6M	2094101	408,00 €
8 – 10	0,002	58	1,6	3-P	25 – 14	0,004	0,3	MXTA8M	2094102	375,00 €
10 – 12,5	0,002	58	1,9	3-P	25 – 14	0,004	0,3	MXTA10M	2094103	375,00 €
12,5 – 16	0,002	62	0,5	3-P	29 – 15	0,004	0,3	MXTA12M	2095104	375,00 €
16 – 20	0,002	62	0,5	3-P	29 – 15	0,004	0,5	MXTA16M	2095106	383,00 €
20 – 25	0,005	66	0,5	3-P	29 – 15	0,004	0,5	XTA20M	2095107	402,00 €
25 – 35	0,005	66	0,5	3-P	29 – 15	0,004	0,5	XTA25M	2095109	570,00 €
35 – 50	0,005	80	0,5	3-P	42 – 28	0,004	1,1	XTA35M	2095111	581,00 €
50 – 65	0,005	80	0,5	3-P	42 – 28	0,005	1,1	XTA50M	2095113	697,00 €
65 – 80	0,005	80	0,5	3-P	42 – 28	0,005	1,1	XTA65M	2095114	697,00 €
80 – 100	0,005	100	0,5	3-P	42 – 28	0,005	1,2	XTA80M	2095115	881,00 €
100 – 125	0,005	115	0,5	3-P	50 – 30	0,006	2,1	XTA100M	2095116	974,00 €
125 – 150	0,005	115	0,5	3-P	50 – 30	0,006	2,7	XTA125M	2095117	1.127,00 €
150 – 175	0,005	115	0,5	3-P	50 – 30	0,007	3,5	XTA150M	2095118	1.317,00 €
175 – 200	0,005	115	0,5	3-P	50 – 30	0,007	3,8	XTA175M	2095119	1.505,00 €
200 – 225	0,005	118	0,5	3-P	50 – 30	0,008	3,8	XTA200M	2095120	2.028,00 €
225 – 250	0,005	118	0,5	3-P	50 – 30	0,008	3,8	XTA225M	2095121	2.095,00 €
250 – 275	0,005	118	0,5	3-P	50 – 30	0,009	3,8	XTA250M	2095122	2.281,00 €
275 – 300	0,005	118	0,5	3-P	50 – 30	0,009	3,8	XTA275M	2095123	2.383,00 €

Sätze / Sets

2 – 3	0,001	9	-	2-P	18 – 12	0,004	2,0	SMXTA1M	2094199	1.724,00 €
3 – 6	0,001	12 / 18	-	2-P	18 – 12	0,004	2,0	SMXTA2M	2094200	2.335,00 €
6 – 10	0,002	58	1,6	3-P	25 – 14	0,004	2,0	SMXTA3M	2094201	681,00 €
10 – 20	0,002	58 / 62	1,9 / 0,5	3-P	29 – 14	0,004	2,0	SMXTA4M	2095202	1.019,00 €
20 – 50	0,005	66 / 80	0,5	3-P	42 – 15	0,004	3,2	SXTA5M	2095203	1.526,00 €
50 – 100	0,005	80 / 100	0,5	3-P	42 – 28	0,005	5,0	SXTA6M	2095204	2.071,00 €
100 – 150	0,005	115	0,5	3-P	50 – 30	0,006	7,0	SXTA7M	2095205	1.706,00 €
150 – 200	0,005	115	0,5	3-P	50 – 30	0,007	12,0	SXTA8M	2095206	2.207,00 €

Shop 



Digital-Taschenmessschieber, DIGI ARCER IP67

Digital pocket calipers, DIGI ARCER IP67



No. 1850151ip

PROMO
→ 30.06.2026!

+ 20% EXTRA-RABATT
AB 10 STÜCK!

+ 20% EXTRA DISCOUNT
FROM 10 PIECES!

- ▶ DIN 862
- ▶ Schutzart IP67, Sylvac System
- ▶ Feststellschraube
- ▶ rostfreier Stahl, gehärtet
- ▶ großes LCD Display
- ▶ Kreuzspitzen
- ▶ Tiefenmaß eckig
- ▶ 4-fach Messung
- ▶ Lieferung im Etui

Funktionen:

- ▶ Ein/Aus, Auto-On bei Bewegung, mm/inch Umschaltung, 0-Punkt an jeder Position, ABS-Funktion (fester 0-Punkt), absolutes System, ± Preset Funktion, Datenausgang Proximity

- ▶ DIN 862
- ▶ Protection class IP67, Sylvac System
- ▶ Locking screw
- ▶ Hardened stainless steel
- ▶ Large LCD display
- ▶ Cross points
- ▶ Depth gauge angular
- ▶ 4-way measurement
- ▶ Delivered in a case

Functions:

- ▶ On/Off, Auto-On by sliding, mm/inch commutation, Zero setting at any position, ABS function (fixed 0 point), absolute system, ± Preset function, Data output Proximity

Alle Preise abzüglich Rabatt! / Rabatt anfragen
All prices less discount! / Ask for discount

+49 (0) 6021 42999 00

-%

mm	inch	mm	mm	inch	kg	Nº DEMM	Nº	1 Stück / 1 piece!
150	6	40	0,01	.0005	0,15	ST15040RIP67	1850151ip	175,00 €
200	8	50	0,01	.0005	0,23	ST20050RIP67	1850152ip	257,00 €

Shop 

Digital-Taschenmessschieber IP67, ULTRA active mit Bluetooth-Funktion

Digital pocket calipers IP 67, ULTRA active with Bluetooth-function



No. 6850131

AB LAGER!
EX STOCK!

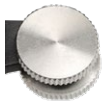

Reibrad demontierbar
Friction wheel removable

- ▶ DIN 862
- ▶ Schutzart IP67
- ▶ Feststellschraube
- ▶ Reibrad demontierbar
- ▶ rostfreier Stahl gehärtet
- ▶ großes LCD Display
- ▶ Kreuzspitzen
- ▶ Tiefenmaß eckig
- ▶ 4-fach Messung
- ▶ Batterie CR 2032 3V
- ▶ Lieferung im Etui

Funktionen:

- ▶ Auto Ein/Aus
- ▶ mm/inch Umschaltung
- ▶ 0-Punkt an jeder Position
- ▶ Datenübertragungstaste
- ▶ Bluetooth-Funktion für PC, Laptop, Tablet und Smartphone
- ▶ sofortige Anzeige der Messwerte in MS-Office (Word, Excel etc.), keine zusätzliche Treiber oder Software erforderlich.

- ▶ DIN 862
- ▶ Protection class IP67
- ▶ Locking screw
- ▶ Friction wheel removable
- ▶ Hardened stainless steel
- ▶ Large LCD display
- ▶ Cross points
- ▶ Depth gauge angular
- ▶ 4-way measurement
- ▶ Battery CR 2032 3V
- ▶ Delivered in a case

Functions:

- ▶ Auto On/Off
- ▶ mm/inch commutation
- ▶ Zero setting at any position
- ▶ Data transmission button
- ▶ Bluetooth connection for PC, laptop, tablet and smartphone
- ▶ Immediate measuring results in MS Office (Word, Excel etc.), no additional driver or software necessary

Alle Preise abzüglich Rabatt! / Rabatt anfragen
All prices less discount! / Ask for discount

+49 (0) 6021 42999 00

-%

mm	inch	mm	mm	inch	kg	Nº	
150	6	40	0,01	.0005	0,4	6850131	164,00 €





Digital-Messschieber DIGI PLUTO BS IP67 ohne Spitzen

Digital calipers DIGI PLUTO BS IP67 without points

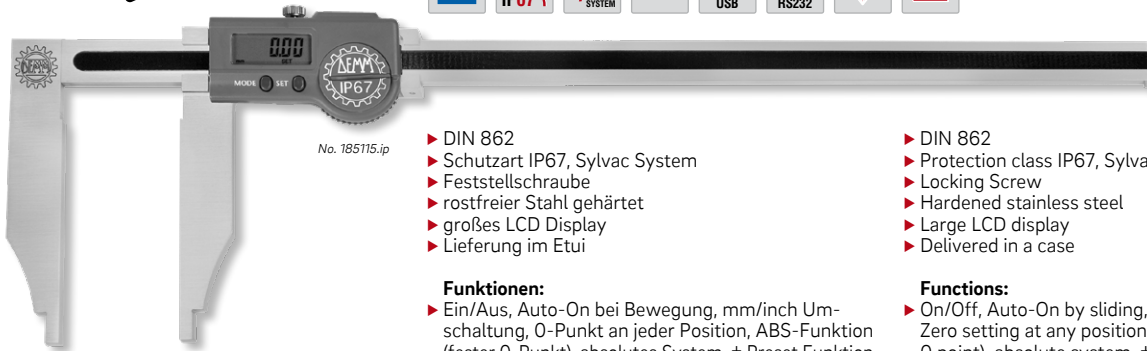

No. 185115.ip

- ▶ DIN 862
- ▶ Schutzart IP67, Sylvac System
- ▶ Feststellschraube
- ▶ rostfreier Stahl gehärtet
- ▶ großes LCD Display
- ▶ Lieferung im Etui

Funktionen:

- ▶ Ein/Aus, Auto-On bei Bewegung, mm/inch Umschaltung, 0-Punkt an jeder Position, ABS-Funktion (fester 0-Punkt), absolutes System, ± Preset Funktion, Datenausgang Proximity

- ▶ DIN 862
- ▶ Protection class IP67, Sylvac System
- ▶ Locking Screw
- ▶ Hardened stainless steel
- ▶ Large LCD display
- ▶ Delivered in a case

Functions:

- ▶ On/Off, Auto-On by sliding, mm/inch commutation, Zero setting at any position, ABS function (fixed 0 point), absolute system, ± Preset function, Data output Proximity

**AB LAGER!
EX STOCK!**

! Größere Messbereiche siehe Shop.

! Larger measuring ranges see shop.

Alle Preise abzüglich Rabatt! / Rabatt anfragen +49 (0) 6021 42999 00
All prices less discount! / Ask for discount

-%

mm	inch	mm	mm	inch	kg	Nº DEMM	Nº	Nº
300	12	100	0,01	.0005	0,72	00450	185115ip	604,00 €
400	16	100	0,01	.0005	0,82	00451	1851152ip	689,00 €
500	20	100	0,01	.0005	0,92	00452	1851153ip	742,00 €



Digital-Messschieber DIGI PLUTO BD IP67 mit Spitzen

Digital calipers DIGI PLUTO BD IP67 with points



No. 185116.ip

- ▶ DIN 862
- ▶ Schutzart IP67, Sylvac System
- ▶ Feststellschraube
- ▶ rostfreier Stahl gehärtet
- ▶ großes LCD Display
- ▶ Lieferung im Etui

Funktionen:

- ▶ Ein/Aus, Auto-On bei Bewegung, mm/inch Umschaltung, 0-Punkt an jeder Position, ABS-Funktion (fester 0-Punkt), absolutes System, ± Preset Funktion, Datenausgang Proximity

- ▶ DIN 862
- ▶ Protection class IP67, Sylvac System
- ▶ Locking Screw
- ▶ Hardened stainless steel
- ▶ Large LCD display
- ▶ Delivered in a case

Functions:

- ▶ On/Off, Auto-On by sliding, mm/inch commutation, Zero setting at any position, ABS function (fixed 0 point), absolute system, ± Preset function, Data output Proximity

**AB LAGER!
EX STOCK!**

! Größere Messbereiche siehe Shop.

! Larger measuring ranges see shop.

Alle Preise abzüglich Rabatt! / Rabatt anfragen +49 (0) 6021 42999 00
All prices less discount! / Ask for discount

-%

mm	inch	mm	mm	inch	kg	Nº DEMM	Nº	Nº
300	12	100	0,01	.0005	0,72	00460	1851161ip	705,00 €
400	16	100	0,01	.0005	0,82	00461	1851162ip	783,00 €
500	20	100	0,01	.0005	0,92	00462	1851163ip	836,00 €

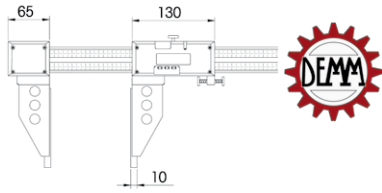

Digital-Messschieber ARGO und ARGO BD CARBON, IP67 ohne Feineinstellung

Digital calipers ARGO and ARGO BD CARBON, IP67 without fine adjustment



Stangenquerschnitt
Bar cross section
40x13mm

No. 185195..ip
ARGO

- ▶ Werksnorm
- ▶ Schutzart IP67, Sylvac System
- ▶ Feststellschraube
- ▶ Mit konstanter Messkraft durch Feder
- ▶ Neues sehr verwindungssteifes Carbonprofil
- ▶ Führungselemente aus verchromten Stahl
- ▶ Messflächen aus rostfreiem Stahl, TIN beschichtet
- ▶ Extrem geringes Gewicht
- ▶ großes LCD Display
- ▶ Lieferung im Etui

- ▶ Works standard
- ▶ Protection class IP67, Sylvac System
- ▶ Locking screw
- ▶ With constant measuring force due spring
- ▶ New carbon profile with high strength of shape
- ▶ Guiding elements made of chromed steel
- ▶ Measuring faces made of stainless steel, TIN coated
- ▶ Extremely low weight
- ▶ Large LCD display
- ▶ Delivered in a case

Messzapfen Ø 5mm
Measuring pins Ø 5mm

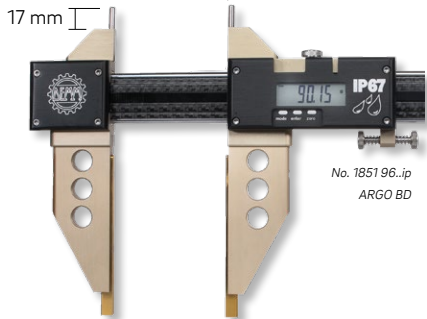

No. 185196..ip
ARGO BD

- Funktionen:**
- ▶ Ein/Aus, Auto-On bei Bewegung
 - ▶ mm/inch Umschaltung
 - ▶ 0-Punkt an jeder Position
 - ▶ ABS-Funktion (fester 0-Punkt)
 - ▶ Absolutes System
 - ▶ Preset Funktion ±
 - ▶ Hold Funktion
 - ▶ Datenausgang Proximity

- Functions:**
- ▶ On/Off, Auto-On by sliding
 - ▶ mm/inch commutation
 - ▶ Zero setting at any position
 - ▶ ABS function (fixed 0 point)
 - ▶ Absolute system
 - ▶ Preset function ±
 - ▶ Hold function
 - ▶ Data output Proximity

1851950ip – 1851956ip :
Ohne zylindrische Messzapfen Ø 5mm

1851950ip – 1851956ip :
Without cylindrical measuring pins Ø 5mm

1851960ip – 1851966ip :
Mit zylindrischen Messzapfen Ø 5mm

1851960ip – 1851966ip :
With cylindrical measuring pins Ø 5mm

Alle Preise abzüglich Rabatt! / Rabatt anfragen
All prices less discount! / Ask for discount

+49 (0) 6021 42999 00

-%

mm	inch	mm	mm	inch	kg	Nº	Nº	kg	Nº	Nº	Nº	
800	32	150	0,01	.0005	1,65	00617	1851950ip	1.643,00 €	1,7	00619	1851960ip	1.862,00 €
800	32	200	0,01	.0005	1,78	00618	1851950xip	2.137,00 €	-	-	-	-
1000	40	150	0,01	.0005	1,85	00312	1851951ip	1.929,00 €	1,9	00565	1851961ip	2.104,00 €
1000	40	200	0,01	.0005	1,98	00313	1851952ip	2.443,00 €	2,03	00566	1851962ip	2.607,00 €
1500	60	150	0,01	.0005	2,2	00314	1851953ip	2.497,00 €	2,25	00567	1851963ip	2.826,00 €
1500	60	200	0,01	.0005	2,33	00315	1851954ip	3.011,00 €	2,38	00568	1851964ip	3.504,00 €
2000	80	150	0,01	.0005	2,6	00316	1851955ip	3.263,00 €	2,65	00569	1851965ip	3.614,00 €
2000	80	200	0,01	.0005	2,73	00317	1851956ip	4.072,00 €	2,78	00577	1851966ip	4.270,00 €

💡 Wussten Sie schon? Did you know?

Sie benötigen analoge Messschieber bis
Messbereich 3000mm?

Kein Problem! Jetzt das komplette
Sortiment im Shop erleben!

You need analogue precision calipers until
measuring range 3000mm?

No problem! Discover the
full range in our shop!

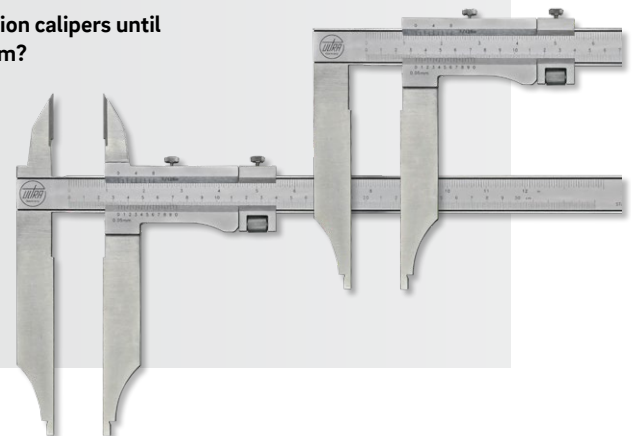



**Digital-Messschieber
ZEUS CARBON mit Messerspitzen**

**Digital calipers
ZEUS CARBON with knife points**



No. 18517.

- ▶ Werksnorm
- ▶ Schutzart IP54, Sylvac System
- ▶ Feststellschraube und Feineinstellung
- ▶ Sehr verwindungssteifes Carbonprofil, Führungselemente aus verchromtem Stahl
- ▶ Messflächen und Messerspitzen aus rostfreiem Stahl, TIN beschichtet
- ▶ Extrem geringes Gewicht
- ▶ großes LCD Display
- ▶ Lieferung im Holzetui

Funktionen:

- ▶ Ein/Aus, mm/inch Umschaltung, 0-Punkt an jeder Position, Hold Funktion, Datenausgang Opto

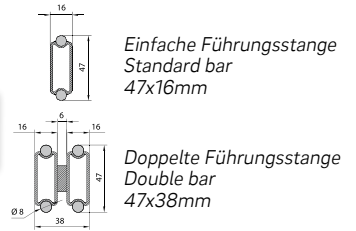

- ▶ Works standard
- ▶ Protection class IP54, Sylvac System
- ▶ Locking screw and fine adjustment
- ▶ Carbon profile with high strength of shape, guiding elements made of chromed steel
- ▶ Measuring faces and knife points made of stainless steel, TIN coated
- ▶ Extremely low weight
- ▶ Large LCD display
- ▶ Delivered in wooden box

Functions:

- ▶ On/Off, mm/inch commutation, Zero setting at any position, Hold function, Data output Opto

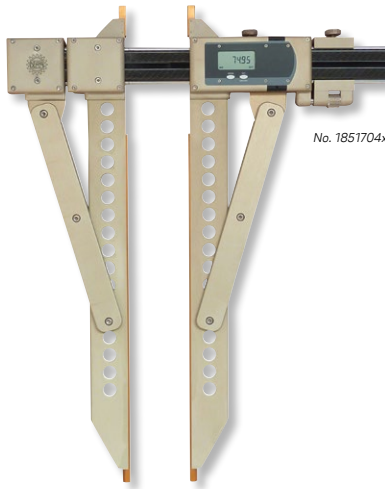

No. 1851704x

Verstärkte Messschnäbel ab 500mm
Reinforced measuring jaws from 500mm

Alle Preise abzüglich Rabatt! / Rabatt anfragen **+49 (0) 6021 42999 00** **-%**
All prices less discount! / Ask for discount

mm	inch	mm	mm	mm	inch	mm	kg	Nº	DEMM	Nº
Einfache Führungsstange 47x16mm / Standard bar 47x16mm										
1000	40	150	47x16	0,01	.0005	0,03	2,5	00900		1851701 2.147,00 €
1000	40	200	47x16	0,01	.0005	0,03	2,6	00901		1851702 2.628,00 €
1000	40	300	47x16	0,01	.0005	0,03	2,8	00908		1851703 3.504,00 €
1000	40	500	47x16	0,01	.0005	0,04	3,2	00909		1851704 4.270,00 €
1500	60	150	47x16	0,01	.0005	0,05	3,2	00915		1851704x 3.230,00 €
1500	60	200	47x16	0,01	.0005	0,05	3,3	00902		1851705 3.613,00 €
1500	60	300	47x16	0,01	.0005	0,06	3,5	00910		1851706 4.598,00 €
1500	60	500	47x16	0,01	.0005	0,06	3,9	00916		1851706x 5.474,00 €
2000	80	150	47x16	0,01	.0005	0,06	3,3	00903		1851707x 3.942,00 €
2000	80	200	47x16	0,01	.0005	0,06	3,5	00904		1851707 4.325,00 €
2000	80	300	47x16	0,01	.0005	0,07	3,7	00911		1851708 5.911,00 €
2000	80	500	47x16	0,01	.0005	0,07	4,1	00914		1851708x 6.677,00 €
2500	100	200	47x16	0,01	.0005	0,07	3,7	00912		1851709 6.020,00 €
2500	100	300	47x16	0,01	.0005	0,08	3,9	00913		1851710 6.677,00 €
3000	120	200	47x16	0,01	.0005	0,08	4,0	00905		1851711 6.656,00 €
3000	120	300	47x16	0,01	.0005	0,09	4,2	00907		1851712 7.115,00 €
3500	138	200	47x16	0,01	.0005	0,10	4,9	00917		1851713 7.312,00 €
3500	138	300	47x16	0,01	.0005	0,10	5,1	00918		1851714 7.772,00 €
Doppelte Führungsstange 47x38mm / Double bar 47x38mm										
4000	157	200	47x38	0,01	.0005	0,12	5,8	00919		1851715 13.134,00 €
4000	157	300	47x38	0,01	.0005	0,12	6,0	00920		1851716 14.228,00 €
4500	178	200	47x38	0,01	.0005	0,15	6,5	00927		1851717 15.869,00 €
4500	178	300	47x38	0,01	.0005	0,15	6,7	00928		1851718 16.854,00 €
5000	197	200	47x38	0,01	.0005	0,18	7,2	00929		1851719 17.128,00 €
5000	197	300	47x38	0,01	.0005	0,18	7,4	00930		1851720 18.169,00 €

Wussten Sie schon? Did you know?

Der ULTRA-Shop unterstützt Sie im täglichen Umgang mit allen Produkten. Durch die vielen innovativen Features erhalten Sie einen optimalen Zugriff auf das gesamte Sortiment.

The ULTRA shop supports you in the daily handling of all products. Many additional features give you an optimal access to the entire range.

www.ultra-germany.shop

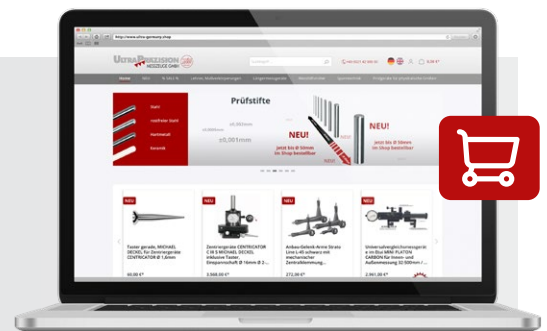

Messplatten aus Naturhartgestein inklusive Verpackung



- ▶ DIN 876
- ▶ aus feinstem Naturhartgestein mit besonders homogener Struktur
- ▶ Messfläche diamantgeläppt, korrosionsfest und säurebeständig
- ▶ Außenflächen sauber geschliffen
- ▶ Härte 6–7 nach Mos'scher Skala
- ▶ Unterseite mit 3 Stahlkugeleinsätzen versehen, für die statisch richtige Lagerung
- ▶ Lieferung inkl. Verpackung, Stahlkugeleinsätze und Kalibrierschein

Genauigkeit:

- ▶ Die Endbearbeitung erfolgt im Klimaraum bei konstanter Temperatur und Luftfeuchte. Zur Endkontrolle werden Messgeräte eingesetzt, die den Maßanschluss an nationale und internationale Prüflaboratorien, garantieren.

15011..:

Güte 00, sehr hohe Genauigkeit für den Messraum

15021..:

Güte 0, hohe Genauigkeit für die Fertigung

- ! Nr. 1500 1.. Güte 000, höchste Genauigkeit für das Labor, siehe Shop.

Granite measuring plates including packing

- ▶ DIN 876
- ▶ Made from finest natural granite with a particularly homogeneous structure
- ▶ Measuring surface diamond lapped, corrosion-resistant and acid-resistant
- ▶ Finely grounded outer surface
- ▶ Hardness 6–7 on Moh's scale
- ▶ Bottom surface with 3 statically correct mounted steel ball inserts as bearing points
- ▶ Delivered incl. packing, steel ball inserts and calibration certificate

Accuracy:

- ▶ The final machining takes place in the climate room at a constant temperature and humidity. For final inspection, measuring devices are used, which are traceable to national and international calibration laboratories.

15011..:

Grade 00, very high precision for control room

15021..:

Grade 0, high precision for production

- ! See our shop for no. 1500 1.. grade 000, highest precision for laboratory.

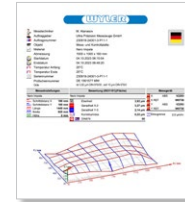
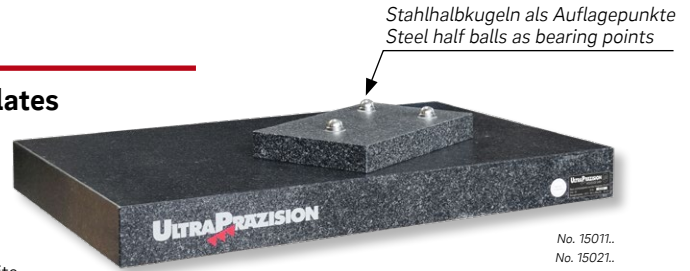

Inkl. Werks-Kalibrierschein
Incl. works calibration certificate

**AB LAGER!
EX STOCK!**

**INKL. VERPACKUNG!
INCL. PACKING!**

Alle Preise abzüglich Rabatt! / Rabatt anfragen
All prices less discount! / Ask for discount

+49 (0) 6021 42999 00

-%

L mm	h kg	μ	00 Nº		μ	0 Nº	
400x250x50	16,0	3	1501102	436,00 €	6	1502102	252,00 €
400x400x50	25,0	3	1501103	580,00 €	6	1502103	345,00 €
500x400x90	50,0	3	1501104	705,00 €	6	1502104	382,00 €
630x400x70	55,0	3	1501106	780,00 €	7	1502106	477,00 €
630x630x70	86,0	3	1501107	945,00 €	7	1502107	729,00 €
800x600x80	110,0	4	1501108	1.076,00 €	7	1502108	792,00 €
800x600x120	173,0	4	1501109	1.229,00 €	7	1502109	956,00 €
1000x630x100	195,0	4	1501110	1.430,00 €	8	1502110	1.040,00 €
1000x1000x100	310,0	4	1501112	2.054,00 €	8	1502112	1.545,00 €
1200x800x120	375,0	5	1501114	2.247,00 €	9	1502114	1.804,00 €
1200x800x160	450,0	5	1501115	2.554,00 €	9	1502115	1.940,00 €
1500x1000x160	700,0	5	1501116	3.468,00 €	10	1502116	2.804,00 €
2000x1000x200	1160,0	6	1501117	5.504,00 €	12	1502117	4.604,00 €

Wussten Sie schon? Did you know?

Wir bieten individuelle Anpassungen wie Stahl T-Nutschienen, Gewindeeinsätze oder Bohrungen nach Ihren Wünschen an.

Mit diesem Zubehör können Sie auf unseren Platten problemlos Reitstöcke, Messstative, Werkstücke oder anderen Komponenten und Aufbauten spannen oder montieren.

We offer customizations such as steel T-slot bars, thread inserts, or bores according to your requirements.

With this accessories, you can easily clamp or mount tailstocks, measuring stands, workpieces, or other components and structures on our plates.

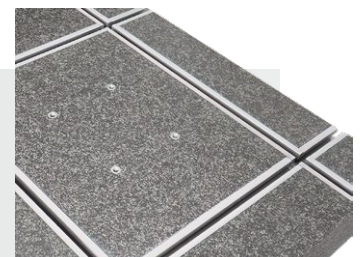

Messplatten aus Naturhartgestein inkl. Schrankunterbau und Verpackung



- ▶ DIN 876
- ▶ aus feinstem Naturhartgestein mit besonders homogener Struktur
- ▶ Messfläche diamantgeläppt, korrosionsfest und säurebeständig
- ▶ Außenflächen sauber geschliffen
- ▶ Härte 6-7 nach Mos'scher Skala
- ▶ Lieferung inkl. Verpackung und Kalibrierschein

Schrankunterbau:

- ▶ aus stabilem Vierkanrohr mit Schubladenmodul
- ▶ 3 Schubladen mit Teleskopeinsätzen
- ▶ inklusive Lagergarnitur und Kippschutz
- ▶ Standfüße höhenverstellbar
- ▶ Baumaße für Arbeitshöhe ca. 900 - 950mm

15032.. :

Güte 00, sehr hohe Genauigkeit für den Messraum, inkl. Schrank

15031.. :

Güte 0, hohe Genauigkeit für die Fertigung, inkl. Schrank

Granite measuring plates Incl. base tool cabinet and packing

- ▶ DIN 876
- ▶ Made from finest natural granite with a particularly homogeneous structure
- ▶ Measuring surface diamond lapped, corrosion-resistant and acid-resistant
- ▶ Finely grounded outer surface
- ▶ Hardness 6-7 on Moh's scale
- ▶ Delivered incl. packing and calibration certificate

Base tool cabinet:

- ▶ Stable square pipe with drawer module
- ▶ 3 drawers with telescope inserts
- ▶ Including levelling screw and tilt protection
- ▶ Height adjustable base
- ▶ Construction for approx. 900 - 950mm working height

15032.. :

Grade 00, very high precision for control room, incl. cabinet

15031.. :

Grade 0, high precision for production, incl. cabinet



No. 1503..

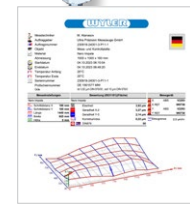

Inkl. Werks-Kalibrierschein
Incl. works calibration certificate

**AB LAGER!
EX STOCK!**

**INKL. VERPACKUNG!
INCL. PACKING!**

Alle Preise abzüglich Rabatt! / Rabatt anfragen
All prices less discount! / Ask for discount

+49 (0) 6021 42999 00

-%

L mm	h kg	∠ μ	00 Nº		∠ μ	0 Nº	
1000x630x100	240,0	4	1503210	3.763,00 €	8	1503110	2.904,00 €
1200x800x120	418,0	5	1503214	4.982,00 €	9	1503114	3.744,00 €
1500x1000x160	802,0	5	1503216	7.134,00 €	10	1503116	5.504,00 €

Messplatten aus Naturhartgestein inkl. Untergestell und Verpackung



- ▶ DIN 876
- ▶ aus feinstem Naturhartgestein mit besonders homogener Struktur
- ▶ Messfläche diamantgeläppt, korrosionsfest und säurebeständig
- ▶ Außenflächen sauber geschliffen
- ▶ Härte 6-7 nach Mos'scher Skala
- ▶ Lieferung inkl. Verpackung und Kalibrierschein

Untergestell:

- ▶ aus stabilem Vierkanrohr, lackiert
- ▶ inkl. Lagergarnitur und Kippschutz
- ▶ Baumaße für Arbeitshöhe von ca. 900 - 950mm

15042.. :

Güte 00, sehr hohe Genauigkeit für den Messraum, inkl. Untergestell

15041.. :

Güte 0, hohe Genauigkeit für die Fertigung, inkl. Untergestell

Granite measuring plates Incl. stand and packing

- ▶ DIN 876
- ▶ Made from finest natural granite with a particularly homogeneous structure
- ▶ Measuring surface diamond lapped, corrosion-resistant and acid-resistant
- ▶ Finely grounded outer surface
- ▶ Hardness 6-7 on Moh's scale
- ▶ Delivered incl. packing and calibration certificate

Stand:

- ▶ Stable square pipe
- ▶ Incl. levelling screw and tilt protection
- ▶ Construction for approx. 900 - 950mm working height

15042.. :

Grade 00, very high precision for control room, incl. stand

15041.. :

Grade 0, high precision for production, incl. stand



No. 1504..

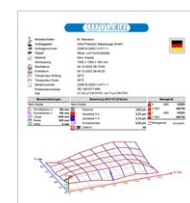

Inkl. Werks-Kalibrierschein
Incl. works calibration certificate

**AB LAGER!
EX STOCK!**

**INKL. VERPACKUNG!
INCL. PACKING!**

Alle Preise abzüglich Rabatt! / Rabatt anfragen
All prices less discount! / Ask for discount

+49 (0) 6021 42999 00

-%

L mm	h kg	∠ μ	00 Nº		∠ μ	0 Nº	
800x600x80	137,0	4	1504208	1.814,00 €	7	1504108	1.591,00 €
800x600x120	200,0	4	1504209	1.952,00 €	7	1504109	1.706,00 €
1000x630x100	230,0	4	1504210	2.440,00 €	8	1504110	1.963,00 €
1000x1000x100	346,0	4	1504212	2.823,00 €	8	1504112	2.364,00 €
1200x800x120	411,0	5	1504214	3.337,00 €	9	1504114	2.420,00 €
1200x800x160	486,0	5	1504215	3.477,00 €	9	1504115	2.894,00 €
1500x1000x160	752,0	5	1504216	4.643,00 €	10	1504116	3.787,00 €
2000x1000x200	1215,0	6	1504217	6.410,00 €	12	1504117	5.555,00 €

Rundlaufprüfgeräte ULTRA *active* mit Hartgestein-Messbank



- ▶ DIN 876
- ▶ Messflächen Güte 1, feingeschliffen
- ▶ linker Reitstock mit fester Pinole
- ▶ rechter Reitstock mit beweglicher Pinole, arretierbar
- ▶ maximale Belastung Reitstockpaar 40 kg
- ▶ Reitstöcke ohne Prismenaufsatz
- ▶ Zentrierspitzen 60°, MK2
- ▶ Messstativ mit Feineinstellung
- ▶ Messuhraufnahme Ø 8mm
- ▶ Lieferung einzeln verpackt, inkl. Werkskalibrierschein für die Hartgestein-Messbank

I Zusätzliche Stative für Mehrstellenmessung siehe Shop.

Concentricity testers ULTRA *active* with granite bench

- ▶ DIN 876
- ▶ Finely ground measuring faces, grade 1
- ▶ Left tailstock with fixed centre sleeve
- ▶ Right tailstock with movable and lockable centre sleeve
- ▶ Maximum load tailstock pair 40 kg
- ▶ Tailstocks without V blocks
- ▶ Centre points 60°, MK2
- ▶ Measuring stand with fine adjustment
- ▶ Dial mounting hole Ø 8mm
- ▶ Delivered in individual packages, incl. works calibration certificate for granite bench

I Additional stands for multi-point measurement see shop.



PROMO
→ 31.12.2025!



**Solange der Vorrat reicht!
While stocks last!**

ℓ mm	ℓ ₁ mm	ℓ ₂ mm	T-Nute / T-slot mm	⊖ kg	Nº	Listenpreis Listprice	Aktionspreis Promotion price
200	650	1100x200x140	14H7	144,5	1554101	5.693,00 €	4.060,00 €
200	850	1300x200x140	14H7	161,5	1554102	6.167,00 €	4.999,00 €
200	1150	1600x200x140	14H7	186,5	1554103	6.587,00 €	5.522,00 €
200	1550	2000x200x160	14H7	240,3	1554104	6.965,00 €	6.697,00 €

% Rabatt
Discount

**% Wichtiger Bestellhinweis % Ihr regulärer Rabatt gilt auch für die bereits reduzierten Aktionspreise!
% Important order notice % Your regular discount also applies to the already reduced promotional prices!**

💡 Wussten Sie schon? Did you know?

Sie benötigen Rundlaufprüfgeräte für größere Werkstücke?

Kein Problem! ULTRA hat die Lösung!
Wir freuen uns auf Ihre Anfragen. Oder schauen Sie doch einfach mal im Shop vorbei?

You require concentricity testers for larger work pieces?

No problem! ULTRA has the solution!
We are looking forward to your inquiries. Or you take a closer look at our shop?



Rundlaufprüfgerät mit Hartgesteinbasis, Unterschrank Sonderanfertigung
Concentricity testers with granite base, Tool cabinet special design

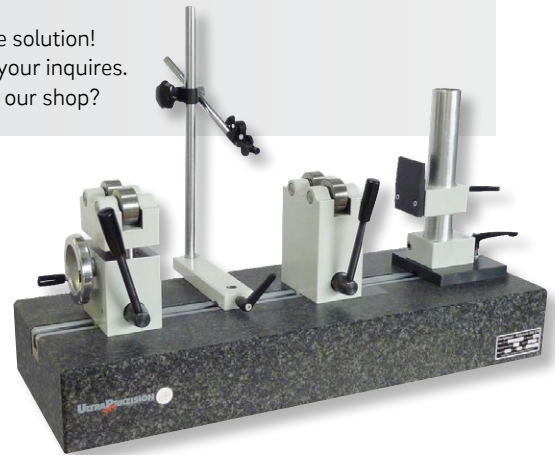

Rundlaufprüfgeräte mit Abrollböcken
Concentricity testers with rolling blocks

Rollenböcke
Roller blocks



Rundlaufprüfgeräte SIMMY mit Messstativen



- ▶ Werksnorm
- ▶ zur Rundlauf- und Planschlagprüfung
- ▶ Rundlaufgenauigkeit 0,002mm
- ▶ Präzisionsrollen Ø30mm mit Einstich aus gehärtetem Stahl
- ▶ Antrieb durch seitliches Handrad
- ▶ Gehäuse aus eloxiertem Aluminium
- ▶ Wellen zur Stativführung aus hartverchromtem Stahl
- ▶ Niederhalter für Werkstücke federbelastet
- ▶ Werkstückanschlag, längen- und höhenverstellbar
- ▶ 2 Stative für Fühlhebelmessgeräte, Aufnahmebohrung Ø 8mm
- ▶ Lieferung einzeln verpackt ohne Fühlhebelmessgeräte

155950. :
SIMMY Rollenbock fest

155951. :
SIMMY DS mit zusätzlich verschiebbaren Rollenbock

Concentricity testers SIMMY with measuring stands

- ▶ Works standard
- ▶ For checking concentricity and wobble
- ▶ Concentricity accuracy 0.002mm
- ▶ Precision rollers Ø30mm with groove made of hardened tool steel
- ▶ Drive with hand wheel on side face
- ▶ Aluminium housing, anodized
- ▶ Hard chromed steel bars for measuring stand sliding
- ▶ Spring loaded work piece clamping system
- ▶ Work piece anvil adjustable in length and height
- ▶ 2 measuring stands for dial test indicators, mounting hole Ø 8mm
- ▶ Delivered in individual packages without dial test indicators

155950. :
SIMMY fixed rolling block

155951. :
SIMMY DS with additional movable rolling block



Stativ mit Gewindespindel durch Handrad verschiebbar
Stand with threaded spindle movable by hand wheel

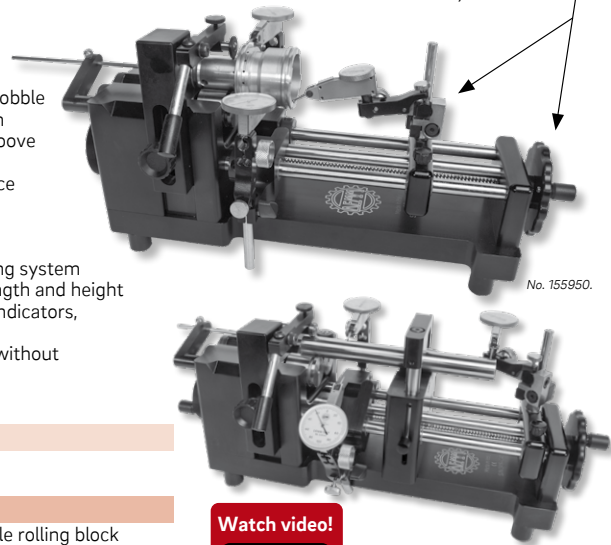

No. 155950.

No. 155951.

Watch video!



**MEHR GERÄTE?
MORE DEVICES?**

Siehe Shop! See shop!



Alle Preise abzüglich Rabatt! / Rabatt anfragen
All prices less discount! / Ask for discount

+49 (0) 6021 42999 00

-%

L mm	Werkstück Work piece Ø mm	kg	Nº DEMM	Nº	kg	Nº DEMM	Nº	kg	Nº
350 x 118 x 140	1,5 – 50	8,5	00879	1559501 3.438,00 €	9	00881	1559511 4.125,00 €		
350 x 118 x 140	10 – 100	8,5	00880	1559502 4.760,00 €	9	00882	1559512 5.605,00 €		

Rundlaufprüfgeräte RLPG mit Abrollscheiben



- ▶ Rundlaufgenauigkeit besser als 0,005mm
- ▶ Abrollscheiben-Ø 120x4mm gehärtet
- ▶ ein Abrollbock höhenverstellbar, Verstellbereich 30mm zum Ausgleich unterschiedlicher Werkstückdurchmesser
- ▶ Stativ mit Feineinstellung, Messuhraufnahme Ø 8mm
- ▶ Lieferung einzeln verpackt, ohne Stativ, ohne Fühlhebelmessgerät

1559702. :
Rundlaufprüfgerät ohne Grundplatte

1559701 + 1559703. :
Träger stufenlos verschiebbar, Fixierung durch Griff mit Grundplatte

Concentricity testers RLPG with roller wheels

- ▶ Concentricity accuracy better than 0.005mm
- ▶ Roller wheels Ø 120x4mm hardened
- ▶ One rolling block height adjustable, range 30mm for adjusting different workpiece diameters
- ▶ Stand with fine adjustment, dial mounting hole Ø 8mm
- ▶ Delivered in individual packages, without stand, without dial test indicator

1559702. :
without base plate

1559701 + 1559703. :
Supports steplessly adjustable, fixation with handle with base plate

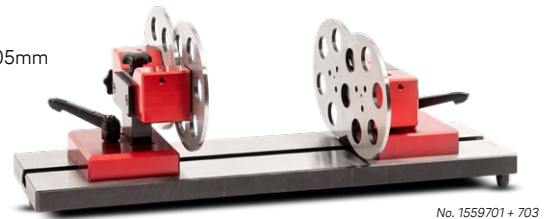

No. 1559701 + 703



Anwendungsbeispiel
Example of use

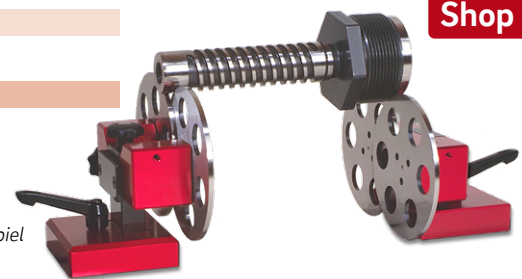

Alle Preise abzüglich Rabatt! / Rabatt anfragen
All prices less discount! / Ask for discount

+49 (0) 6021 42999 00

-%

L mm	Werkstück Workpiece kg	Ø-Ausgleich Ø-Compensation mm	Nuteneinstichbreite Groove stone width mm	Werkstück Workpiece Ø mm	kg	Nº FISSO	Nº	kg	Nº
120x4 / 500	max. 25	max. 60	14	max. 240	13,49	6.300	1559701	5.211,00 €	
120x4	max. 25	max. 60	14	max. 240	4,85	6.301	1559702	4.180,00 €	
120x4 / 1000	max. 25	max. 60	14	max. 240	22,8	6.302	1559703	6.039,00 €	

Feinmesstische mit Hartgestein-Messfläche und glatte Säule



- ▶ DIN 876/00
- ▶ 4 Stück GummifüÙe an der Unterseite
- ▶ Messfläche und Standfuß aus Hartgestein
- ▶ Messuhraufnahme Ø 8mm
- ▶ Lieferung einzeln verpackt

Precision measuring tables with granite surface and flat column

- ▶ DIN 876/00
- ▶ 4 pieces rubber pads at the bottom
- ▶ Granite measuring surface and base
- ▶ Dial mounting hole Ø 8mm
- ▶ Delivered in individual packages



**AB LAGER!
EX STOCK!**

Alle Preise abzüglich Rabatt! / Rabatt anfragen +49 (0) 6021 42999 00 -%

A mm	L1 mm	L2 mm	h mm	Ø mm	mm	kg	Nº	
Querarm verschiebbar / Adjustable arm								
100	170	130	180	22	75	2,6	1419101	275,00 €
Querarm starr / Rigid arm								
100	170	130	180	22	50	2,5	1421101	231,00 €

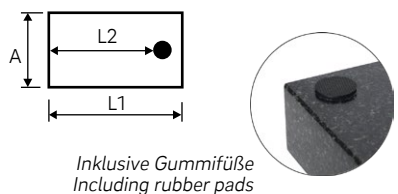

Feinmesstische mit Hartgestein-Messfläche und glatter Säule



- ▶ DIN 876/00
- ▶ 4 Stück GummifüÙe an der Unterseite
- ▶ Messfläche und Standfuß aus Hartgestein
- ▶ Messuhraufnahme Ø 8mm
- ▶ ohne Steilgewinde
- ▶ Lieferung einzeln verpackt

Precision measuring tables with granite surface and flat column

- ▶ DIN 876/00
- ▶ 4 pieces rubber pads at the bottom
- ▶ Granite measuring surface and base
- ▶ Dial mounting hole Ø 8mm
- ▶ Without helical thread
- ▶ Delivered in individual packages



**AB LAGER!
EX STOCK!**

Alle Preise abzüglich Rabatt! / Rabatt anfragen +49 (0) 6021 42999 00 -%

A mm	L1 mm	L2 mm	h mm	Ø mm	mm	kg	Nº	
Querarm verschiebbar / Adjustable arm								
150	250	200	230	35	180	10,0	1419202	384,00 €
200	300	230	230	35	180	14,0	1419203	394,00 €
Querarm starr / Rigid arm								
150	250	200	230	35	120	10,0	1421202	352,00 €
200	300	230	230	35	120	14,0	1421203	368,00 €

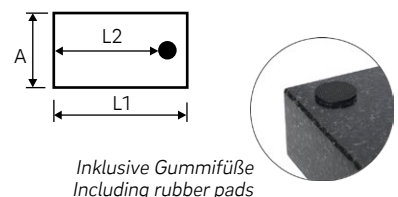

**Feinmesstische mit Hartgestein-
Messfläche und Säule mit
Steilgewinde**

**Precision measuring tables with
granite surface and column with
helical thread**



- ▶ DIN 876/00
- ▶ 4 Stück GummifüÙe an der Unterseite
- ▶ Messfläche und Standfuß aus Hartgestein
- ▶ Querarm verschiebbar
- ▶ Messuhraufnahme Ø 8mm
- ▶ Höhenverstellung durch Steilgewinde mit Stellring
- ▶ Lieferung einzeln verpackt

- ▶ DIN 876/00
- ▶ 4 pieces rubber pads at the bottom
- ▶ Granite measuring surface and base
- ▶ Adjustable arm
- ▶ Dial mounting hole Ø 8mm
- ▶ Height adjustment by helical thread with adjusting ring
- ▶ Delivered in individual packages

**AB LAGER!
EX STOCK!**



No. 1419102

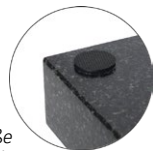
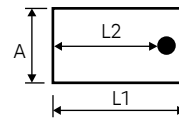

*Inklusive GummifüÙe
Including rubber pads*

Alle Preise abzüglich Rabatt! / Rabatt anfragen **+49 (0) 6021 42999 00** **-%**
All prices less discount! / Ask for discount

A mm	L1 mm	L2 mm	⊥ mm	∅ mm	≡ mm	⚖ kg	Nº	
150	250	200	230	35	180	10,0	1419102	392,00 €
200	300	230	230	35	180	14,0	1419103	455,00 €
250	420	350	230	35	180	26,0	1419103x	503,00 €
250	420	350	400	35	250	28,0	1419104	1.148,00 €
300	470	400	400	35	300	36,0	1419105	1.344,00 €

**Feinmesstische mit Hartgestein-
Messfläche und Säule mit
Steilgewinde**

**Precision measuring tables with
granite surface and column with
helical thread**



- ▶ DIN 876/00
- ▶ 4 Stück GummifüÙe an der Unterseite
- ▶ Messfläche und Standfuß aus Hartgestein
- ▶ Querarm starr mit Feineinstellung
- ▶ Messuhraufnahme Ø 8mm
- ▶ Höhenverstellung durch Steilgewinde mit Stellring
- ▶ Lieferung einzeln verpackt

- ▶ DIN 876/00
- ▶ 4 pieces rubber pads at the bottom
- ▶ Granite measuring surface and base
- ▶ Rigid arm with fine adjustment
- ▶ Dial mounting hole Ø 8mm
- ▶ Height adjustment by helical thread with adjusting ring
- ▶ Delivered in individual packages

**AB LAGER!
EX STOCK!**

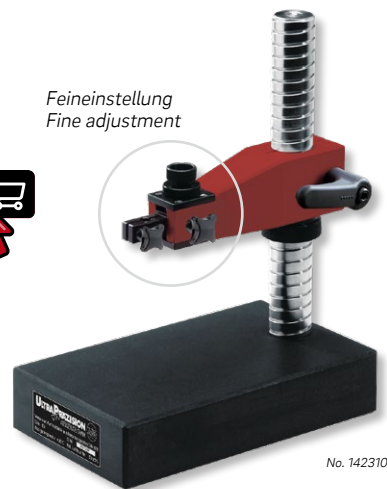

*Feineinstellung
Fine adjustment*

No. 1423101

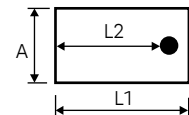

*Inklusive GummifüÙe
Including rubber pads*

*Parallel-Feineinstellung,
Verstellweg ca. 8mm
Parallel fine adjustment,
adjusting range approx. 8mm*

Alle Preise abzüglich Rabatt! / Rabatt anfragen **+49 (0) 6021 42999 00** **-%**
All prices less discount! / Ask for discount

A mm	L1 mm	L2 mm	⊥ mm	∅ mm	≡ mm	⚖ kg	Nº	
150	250	200	230	35	130	10,0	1423101	489,00 €
200	300	230	230	35	130	14,0	1423102	499,00 €
250	420	350	230	35	180	26,0	1423104	599,00 €

Feinmesstische, glatte Säule mit Keramik-Messfläche und Hartgestein-Standfuß



- ▶ DIN 876/00
- ▶ Messfläche aus Keramik, extrem hart und korrosionsbeständig, absolut verschleißfest
- ▶ Standfuß aus Hartgestein
- ▶ 4 Stück GummifüÙe an der Unterseite
- ▶ Messuhraufnahme Ø 8mm
- ▶ Lieferung einzeln verpackt

Precision meas. tables, flat column with ceramic surface and granite base

NEW

- ▶ DIN 876/00
- ▶ Ceramic measuring surface, extremely hard, anti-corrosive and absolutely wear-resistant
- ▶ Granite base
- ▶ 4 pieces rubber pads at the bottom
- ▶ Dial mounting hole Ø 8mm
- ▶ Delivered in individual packages



**AB LAGER!
EX STOCK!**

KERAMIK/CERAMIC

10x härter als Hartgestein
10x harder than granite

Alle Preise abzüglich Rabatt! / Rabatt anfragen
All prices less discount! / Ask for discount **+49 (0) 6021 42999 00** **-%**

A mm	L1 mm	L2 mm	⊖ mm	∅ mm	≡ mm	⚖ kg	Nº	
Querarm verschiebbar / Adjustable arm								
100	200	160	180	22	75	4,2	1419201k	432,00 €
Querarm starr / Rigid arm								
100	200	160	180	22	50	4,1	1421201k	383,00 €

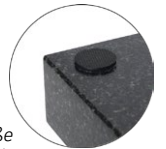
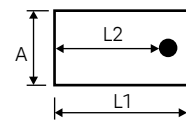

Inklusive GummifüÙe
Including rubber pads

Feinmesstische, Steilgewinde mit Keramik-Messfläche und Hartgestein-Standfuß



- ▶ DIN 876/00
- ▶ Messfläche aus Keramik, extrem hart und korrosionsbeständig, absolut verschleißfest
- ▶ Standfuß aus Hartgestein
- ▶ 4 Stück GummifüÙe an der Unterseite
- ▶ Messuhraufnahme Ø 8mm
- ▶ Höhenverstellung durch Steilgewinde mit Stellring
- ▶ Lieferung einzeln verpackt

Precision meas. tables, helical thread with ceramic surface and granite base

NEW

- ▶ DIN 876/00
- ▶ Ceramic measuring surface, extremely hard, anti-corrosive and absolutely wear-resistant
- ▶ Granite base
- ▶ 4 pieces rubber pads at the bottom
- ▶ Dial mounting hole Ø 8mm
- ▶ Height adjustment by helical thread with adjusting ring
- ▶ Delivered in individual packages

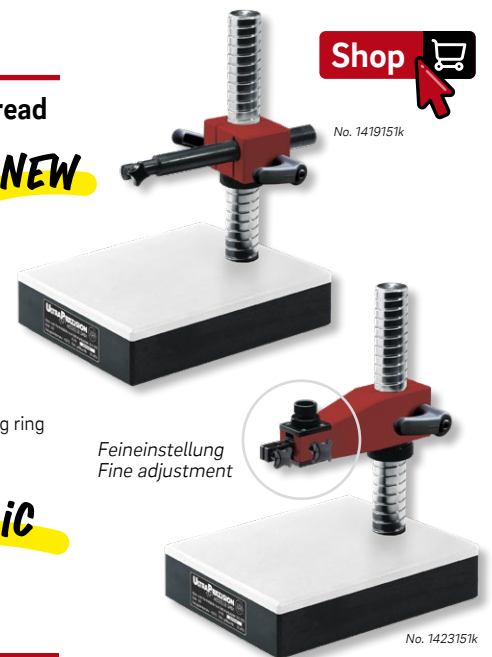

**AB LAGER!
EX STOCK!**

KERAMIK/CERAMIC

10x härter als Hartgestein
10x harder than granite

Alle Preise abzüglich Rabatt! / Rabatt anfragen
All prices less discount! / Ask for discount **+49 (0) 6021 42999 00** **-%**

A mm	L1 mm	L2 mm	⊖ mm	∅ mm	≡ mm	⚖ kg	Nº	
Querarm verschiebbar / Adjustable arm								
200	250	200	230	35	180	11,0	1419151k	881,00 €
Querarm starr / Rigid arm								
200	250	200	230	35	120	10,5	1421151k	841,00 €
Querarm starr, mit Feineinstellung / Rigid arm, with fine adjustment								
200	250	200	230	35	130	16,6	1423151k	987,00 €

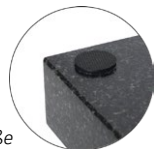
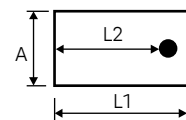

Inklusive GummifüÙe
Including rubber pads

Feineinstellung
Fine adjustment

Positioniervorrichtungen für Werkstücke auf Feinmesstischen



- ▶ Optimal für wiederholbares Positionieren
- ▶ Passend für alle Feinmesstische mit Säulen- Ø 22mm oder Ø 35mm
- ▶ Anschläge aus gehärtetem Stahl
- ▶ mit Höhen- und Längenverstellung
- ▶ Lieferung einzeln verpackt, ohne Messuhr

142990. :
mit geradem Anschlag 60mm

142991. :
mit Prismenanschlag 120° für Werkstücke bis Ø 100mm

Positioning units for work pieces on measuring tables

- ▶ Optimized for repeatable positioning
- ▶ Suitable for all precision measuring tables with column Ø 22mm or Ø 35mm
- ▶ Stops made of hardened steel
- ▶ With height and length adjustment
- ▶ Delivered in individual packages, without dial gauge

142990. :
With straight stop 60mm

142991. :
With prism stop 120° for work pieces up to Ø 100mm

Alle Preise abzüglich Rabatt! / Rabatt anfragen
All prices less discount! / Ask for discount

+49 (0) 6021 42999 00

-%

für / for Ø mm	l mm	Gerade / Straight Nº		Prisma / Prism Nº	
22	60	1429901	171,00 €	120°	1429911 171,00 €
35	60	1429902	180,00 €	120°	1429912 180,00 €

NEW



Universal-Messtische aus Naturhartgestein mit 3D-Gelenkarm



- ▶ DIN 876/0
- ▶ 4 Stück GummifüÙe an der Unterseite
- ▶ MessfläÙe diamantgeläÙpt, korrosionsfest und säurebeständig
- ▶ AuÙenfläÙen sauber geschliffen
- ▶ Massiver 3D-Gelenkarm mit mechanischer Zentralklemmung
- ▶ Gewindeeinsatz M8
- ▶ Messuhraufnahme Ø 8mm mit Feineinstellung
- ▶ Schwalbenschwanzführung
- ▶ Lieferung einzeln verpackt

Universal measuring tables with 3D-articulated arm

- ▶ DIN 876/0
- ▶ 4 pieces rubber pads at the bottom
- ▶ Diamond-lapped, corrosion-proof and acid-resistant measuring surface
- ▶ Finely ground outer surface
- ▶ Solid 3D articulated arm with mechanical centre lock
- ▶ Thread insert M8
- ▶ Dial mounting hole Ø 8mm with fine adjustment
- ▶ Dovetail guide
- ▶ Delivered in individual packages

NEW



Alle Preise abzüglich Rabatt! / Rabatt anfragen
All prices less discount! / Ask for discount

+49 (0) 6021 42999 00

-%

l mm	h mm	h kg	Nº	
400x250x50	340	18	1419301	323,00 €
400x400x50	340	28	1419302	379,00 €

💡 Wussten Sie schon? Did you know?

Sie benötigen weitere Feinmesstische?

Kein Problem! Jetzt das komplette Sortiment im Shop erleben.

You need more precision measuring tables?

No problem! Discover the full range in our shop!

Shop



Magnet-Gelenk-Messstative STRATO Line



- ▶ mit mechanischer Zentralklemmung und Mikrofeineinstellung
- ▶ Querarm beliebig verstellbar
- ▶ Gestänge aus Aluminium
- ▶ Magnetfuß mit prismatischer Sohle
- ▶ Magnet ein- ausschaltbar
- ▶ Messuhraufnahme Ø 8mm
- ▶ Lieferung einzeln verpackt, ohne Messuhr

Articulated measuring stands STRATO Line

- ▶ Mechanical centre lock and micro fine adjustment
- ▶ Freely adjustable arm
- ▶ Aluminium linkage
- ▶ Magnetic V base
- ▶ Switchable magnet
- ▶ Dial mounting hole Ø 8mm
- ▶ Delivered in individual packages, without dial gauge



FISSO
Swiss Made



No. 1400503



No. 1400501

Alle Preise abzüglich Rabatt! / Rabatt anfragen
All prices less discount! / Ask for discount

+49 (0) 6021 42999 00

-%

mm	mm	N	Fuß / Stand mm	kg	Nº FISSO	Nº	
130	220	300	34x30x35	0,45	XS13.50	1400501	232,00 €
200	310	800	60x50x55	1,45	S-20.10	1400502	295,00 €
280	390	800	60x50x55	1,85	M-28.10	1400503	381,00 €
280	390	1000	75x50x55	2,1	M-28.50	1400504	403,00 €

**MEHR STATIVE?
MORE STANDS?**

Siehe Shop! See shop!

Magnet-Gelenk-Messstative CLASSIC Line



- ▶ mit mechanischer Zentralklemmung und Mikrofeineinstellung
- ▶ Querarm beliebig verstellbar
- ▶ Gestänge verchromt
- ▶ Magnetfuß mit prismatischer Sohle
- ▶ Magnet ein- ausschaltbar
- ▶ Messuhraufnahme Ø 8mm
- ▶ Lieferung einzeln verpackt, ohne Messuhr

Articulated measuring stands CLASSIC Line

- ▶ Mechanical centre lock and micro fine adjustment
- ▶ Freely adjustable arm
- ▶ Chrome-plated linkage
- ▶ Magnetic V base
- ▶ Switchable magnets
- ▶ Dial mounting hole Ø 8mm
- ▶ Delivered in individual packages, without dial gauge



FISSO
Swiss Made



No. 1400405



No. 1400400

Alle Preise abzüglich Rabatt! / Rabatt anfragen
All prices less discount! / Ask for discount

+49 (0) 6021 42999 00

-%

mm	mm	N	Fuß / Stand mm	kg	Nº FISSO	Nº	
200	310	-	60x50x55	1,55	2220.10	1400401	270,00 €
288	390	800	60x50x55	1,85	3328.10	1400402	313,00 €
400	510	1000	75x50x55	2,2	3340.10	1400403	351,00 €
450	568	1000	75x50x55	2,8	4445.10	1400404	535,00 €
630	740	1500	120x60x55	5,8	6463.10	1400405	830,00 €

**MEHR STATIVE?
MORE STANDS?**

Siehe Shop! See shop!

Anbau-Gelenk-Arme STRATO Line mit mechanischer Zentralklemmung

Articulated arms STRATO Line with mechanical centre lock



FISSO
Swiss Made



- ▶ Querarm beliebig verstellbar
- ▶ Gestänge aus Aluminium
- ▶ Lieferung einzeln verpackt

- ▶ Freely adjustable arm
- ▶ Aluminium linkage
- ▶ Delivered in individual packages



Watch video!

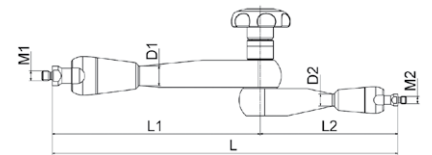

1400531 – 1400533 :
Anbau-Gelenk-Arme STRATO Line rot

1400531 – 1400533 :
Articulated arms STRATO Line red

1400541 – 1400545 :
Anbau-Gelenk-Arme STRATO Line schwarz, für Foto, Video und Optik

1400541 – 1400545 :
Articulated arms STRATO Line black for photo, video and optic

Alle Preise abzüglich Rabatt! / Rabatt anfragen
All prices less discount! / Ask for discount

+49 (0) 6021 42999 00

-%

L mm	L1 mm	L2 mm	D1 mm	D2 mm	Gewinde / Thread	kg	Nº FISSO	Nº	
130	70	60	9	8	M6 / M6	0,15	4.000	1400531	141,00 €
200	120	80	10	9	M8 / M6	0,3	4.100	1400532	168,00 €
280	170	110	16	10	M8 / M6	0,7	4.200	1400533	256,00 €
130	70	60	9	8	M6 / M6	0,15	4.030	1400541	163,00 €
200	100	100	9	9	M6 / M6	0,25	4.120	1400542	175,00 €
250	135	115	10	10	M8 / M6	0,44	4.160	1400543	209,00 €
340	170	170	16	16	M8 / M8	0,9	4.300	1400544	270,00 €
450	223,5	223,5	16	16	M8 / M8	1,05	4.400	1400545	286,00 €

Anbau-Gelenk-Arme CLASSIC Line mit mechanischer Zentralklemmung

Articulated arms CLASSIC Line with mechanical centre lock



FISSO
Swiss Made



- ▶ Querarm beliebig verstellbar
- ▶ Lieferung einzeln verpackt

- ▶ Freely adjustable arm
- ▶ Delivered in individual packages



Watch video!

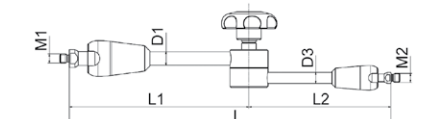

1400431 – 1400438 :
Anbau-Gelenk-Arme CLASSIC Line, verchromt

1400431 – 1400438 :
Articulated arms CLASSIC Line, chromed steel

1400451 – 1400454 :
Anbau-Gelenk-Arme CLASSIC Line, Aluminium

1400451 – 1400454 :
Articulated arms CLASSIC Line, Aluminium

Alle Preise abzüglich Rabatt! / Rabatt anfragen
All prices less discount! / Ask for discount

+49 (0) 6021 42999 00

-%

L mm	L1 mm	L2 mm	D1 mm	D2 mm	Gewinde / Thread	kg	Nº FISSO	Nº	
130	71	59	9	8	M6 / M6	0,21	1.110	1400431	128,00 €
197	112	85	10	9	M8 / M6	0,34	1.220	1400432	144,00 €
288	161	127	12	10	M8 / M6	0,7	1.330	1400433	183,00 €
407	220	187	12	10	M8 / M8	0,8	1.360	1400434	203,00 €
453	260	193	16	12	M8 / M8	1,5	1.440	1400435	388,00 €
559	296	263	12	10	M8 / M8	0,94	1.370	1400436	231,00 €
622	358	264	24	20	M12 / M12	3,63	1.630	1400437	597,00 €
635	373	262	24	16	M10x1,25 / M8	3,41	1.640	1400438	603,00 €
302	151	151	16	16	3/8" / 3/8"	1,02	3.305	1400451	446,00 €
304	152	152	16	16	M10 / M10	1,03	3.307	1400452	446,00 €
400	200	200	16	16	M10 / M10	1,1	3.306	1400453	450,00 €
550	275	275	16	16	M10 / M10	1,23	3.308	1400454	460,00 €

Digital-Messuhren IP65, ULTRA active



- ▶ Werksnorm
- ▶ Schutzart IP65
- ▶ großes LCD-Display, drehbar 270°
- ▶ Aluminiumgehäuse Ø 58mm
- ▶ Einspannschaft Ø 8mm h6
- ▶ Messeinsatz M 2,5 auswechselbar
- ▶ Batterie CR 2032 3V
- ▶ Lieferung in Kartonbox

Funktionen:

- ▶ Ein/Aus, mm/inch Umschaltung, 0-Punkt an jeder Position, Toleranzvorwahl, ABS-Funktion, Messrichtungsumkehr, Datenausgang DIGIMATIC

6301101 – 6301106 :
ohne Abhebevorrichtung

6301122 – 6301126 :
mit Abhebevorrichtung

Digital dial indicators IP65, ULTRA active

- ▶ Works standard
- ▶ Protection class IP65
- ▶ Large LCD display, turnable up to 270°
- ▶ Aluminium housing Ø 58mm
- ▶ Clamping shaft Ø 8mm h6
- ▶ Interchangeable measuring insert M2.5
- ▶ Battery CR 2032 3V
- ▶ Delivered in cardboard box

Functions:

- ▶ On/Off, mm/inch commutation, Zero setting at any position, Tolerance pre-selection, ABS function, Reversible measuring direction, Data output DIGIMATIC

6301101 – 6301106 :
without lifting device

6301122 – 6301126 :
with lifting device



Alle Preise abzüglich Rabatt! / Rabatt anfragen / All prices less discount! / Ask for discount **+49 (0) 6021 42999 00** **-%**

mm	inch approx.	mm	inch	Fehler / Error mm	kg	Nº	
12,5	.5	0,01	.0005	± 0,01	0,36	6301101	128,00 €
25	1	0,01	.0005	± 0,01	0,42	6301102	159,00 €
50	2	0,01	.0005	± 0,02	0,54	6301103	221,00 €
12,5	.5	0,001	.00005	± 0,004	0,36	6301104	215,00 €
25	1	0,001	.00005	± 0,004	0,44	6301105	269,00 €
50	2	0,001	.00005	± 0,005	0,54	6301106	388,00 €
25	1	0,01	.0005	± 0,01	0,55	6301122	175,00 €
50	2	0,01	.0005	± 0,02	0,65	6301123	244,00 €
25	1	0,001	.00005	± 0,004	0,65	6301125	296,00 €
50	2	0,001	.00005	± 0,005	0,65	6301126	427,00 €



NEW!
Mit Abhebevorrichtung!
With lifting device!

Digital-Messuhren ULTRA active



- ▶ Werksnorm
- ▶ großes LCD-Display
- ▶ Aluminiumgehäuse Ø 56mm
- ▶ Einspannschaft Ø 8mm
- ▶ Messeinsatz M 2,5 auswechselbar
- ▶ Batterie CR 2032 3V
- ▶ Lieferung im Etui

Funktionen:

- ▶ Ein/Aus, mm/inch Umschaltung, 0-Punkt an jeder Position

6302100 :
ohne ABS & TOL Funktion

6302101 – 6302102 :
mit ABS & TOL Funktion

Digital dial indicators ULTRA active

- ▶ Works standard
- ▶ Large LCD display
- ▶ Aluminium housing Ø 56mm
- ▶ Clamping shaft Ø 8mm
- ▶ Interchangeable measuring insert M2.5
- ▶ Battery CR 2032 3V
- ▶ Delivered in box

Functions:

- ▶ On/Off, mm/inch commutation, Zero setting at any position

6302100 :
Without ABS & TOL function

6302101 – 6302102 :
With ABS & TOL function



Alle Preise abzüglich Rabatt! / Rabatt anfragen / All prices less discount! / Ask for discount **+49 (0) 6021 42999 00** **-%**

mm	inch approx.	mm	inch	Fehler / Error mm	kg	Nº	
12,5	.5	0,01	.0005	± 0,03	0,2	6302100	81,00 €
12,5	.5	0,01	.0005	± 0,03	0,2	6302101	90,00 €
25	1	0,01	.0005	± 0,03	0,2	6302102	113,00 €

Zentriergeräte CENTRICATOR inklusive Taster



- ▶ Werksnorm
- ▶ horizontal und vertikal einsetzbar
- ▶ Einspannschaft fest Ø 16mm
- ▶ eingebaute, nichtdrehende Messuhr
- ▶ Lieferung im Koffer

Inhalt:

- ▶ Zentriergerät
- ▶ Schnurhalter
- ▶ Magnethalter
- ▶ Taster gerade Kugel Ø 5mm
- ▶ Schraubendreher SW 3
- ▶ Bedienungsanleitung

Centering devices CENTRICATOR including probes

- ▶ Works standard
- ▶ Horizontal and vertical application
- ▶ Fixed clamping shaft Ø 16mm
- ▶ Integrated non-turning dial gauge
- ▶ Delivered in box

Contents:

- ▶ Centering instrument
- ▶ String holder
- ▶ Magnet holder
- ▶ Straight probe, ball Ø 5mm
- ▶ Screwdriver SW 3
- ▶ Operating manual

Watch video!



PROMO
→ 31.12.2025!

Watch video!



Shop

1372101:
CENTRICATOR CO S,
zusätzlich mit gebogenem Kugeltaster Ø 5mm

1372101:
CENTRICATOR CO S,
additionally with bent ball probe Ø 5mm

1373101:
CENTRICATOR C III S,
mit verstellbaren Schlitzen

1373101:
CENTRICATOR C III S,
with adjustable slides

Arbeitsbereich innen Work range inside Ø mm	Arbeitsbereich außen Work range outside Ø mm	Arbeitsbereich plan Work range plane Ø mm	≤ mm	kg	Nº Michael Deckel	Nº	Listenpreis Listprice	Aktionspreis Promotion price	% Rabatt Discount
2 – 125	0 – 125	120 – 160	0,005	0,6	CO S	1372101	2.067,00 €	1.530,00 €	
2 – 400	0 – 300	90 – 480	0,005	0,9	C III S	1373101	4.703,00 €	3.483,00 €	

% Wichtiger Bestellhinweis % Ihr regulärer Rabatt gilt auch für die bereits reduzierten Aktionspreise!
% Important order notice % Your regular discount also applies to the already reduced promotional prices!

Zubehör für CENTRICATOR



- ▶ passend für Zentriergeräte CENTRICATOR Nr. 1372101 und Nr. 1373101
- ▶ Lieferung einzeln verpackt

Accesories for CENTRICATOR

- ▶ Suitable for centering devices CENTRICATOR No. 1372101 and No. 1373101
- ▶ Delivered in individual packages

Shop

MICHAEL DECKEL



Alle Preise abzüglich Rabatt! / Rabatt anfragen **+49 (0) 6021 42999 00**

All prices less discount! / Ask for discount

-%

Typ Type	mm	Nº	
Taster gerade / Straight probes	Ø 1,6	1374301	60,00 €
Taster winkelig / Angular probes	Ø 2,5	1374302	60,00 €
Taster plan / Plain probes	Ø 5	1374303	60,00 €
Verlängerungen / Extensions	105	1374304	263,00 €
Ersatz-Schnurhalter / Spare string holder	30,2 x 27,9	1374401	74,00 €
Ersatz-Magnethalter / Spare magnet holder	30,4 x 55	1374402	74,00 €

Montagelineale aus Stahl



- ▶ DIN 874
- ▶ I-förmiger Querschnitt
- ▶ schmaler oder starker Querschnitt
- ▶ Mit Erleichterungsbohrungen
- ▶ Lieferung einzeln verpackt

I Holzkasten Nr. 1683... zum Transport und zur Aufbewahrung unbedingt erforderlich. Siehe Menü Zubehör im Shop.

Assembling straightedges, steel

- ▶ DIN 874
- ▶ I-profile
- ▶ Narrow or solid profile
- ▶ With relief bores
- ▶ Delivered in individual packages

I Wooden box No. 1683... absolutely necessary for transport and storage. See menu accessories in our shop.



TRANSPORT BOX?
Siehe Shop! See shop!

Alle Preise abzüglich Rabatt! / Rabatt anfragen **+49 (0) 6021 42999 00** **-%**
All prices less discount! / Ask for discount

l mm	b mm	h kg	0 N°	1 N°
schmaler Querschnitt / Narrow profile				
1000mm	100 x 30	5,0	1681101 668,00 €	1682101 565,00 €
1500mm	100 x 30	7,0	1681102 832,00 €	1682102 769,00 €
2000mm	120 x 40	15,0	1681103 1.088,00 €	1682103 1.047,00 €
2500mm	120 x 40	19,0	1681104 1.497,00 €	1682104 1.416,00 €
3000mm	140 x 40	26,0	1681105 1.898,00 €	1682105 1.827,00 €
4000mm	140 x 40	36,0	1681106 2.768,00 €	1682106 2.512,00 €
5000mm	160 x 40	54,0	1681107 4.870,00 €	1682107 4.409,00 €
6000mm	160 x 40	65,0	1681108 5.331,00 €	1682108 4.921,00 €
starker Querschnitt / Solid profile				
1000mm	160 x 50	12,0	1681201 851,00 €	1682201 728,00 €
1500mm	160 x 50	18,0	1681202 1.212,00 €	1682202 996,00 €
2000mm	160 x 50	24,0	1681203 1.539,00 €	1682203 1.293,00 €
2500mm	160 x 50	30,0	1681204 2.196,00 €	1682204 1.632,00 €
3000mm	180 x 60	45,0	1681205 3.313,00 €	1682205 2.717,00 €
4000mm	180 x 60	60,0	1681206 4.615,00 €	1682206 3.640,00 €
5000mm	200 x 80	103,0	1681207 7.792,00 €	1682207 6.305,00 €
6000mm	200 x 80	122,0	1681208 9.585,00 €	1682208 7.790,00 €

Montagelineale Aluminium ULTRA active



- ▶ DIN 874
- ▶ I-förmiger Querschnitt
- ▶ geringes Gewicht
- ▶ ab 1500mm mit Erleichterungsbohrungen
- ▶ Lieferung im Holzkasten

▶ Beschichtungseigenschaften:
- Härte HV 80
- Zugfestigkeit 47kg/mm²
- Streckgrenze 110kg/mm²

Assembling straightedges aluminium ULTRA active

- ▶ DIN 874
- ▶ I-profile
- ▶ Light weight
- ▶ from 1500mm with relief bores
- ▶ Delivered in wooden box

▶ Coating characteristics:
- Hardness HV 80
- Tensile strength 47kg/mm²
- Yield point 110kg/mm²

NEW



Alle Preise abzüglich Rabatt! / Rabatt anfragen **+49 (0) 6021 42999 00** **-%**
All prices less discount! / Ask for discount

l mm	b mm	h kg	DIN 874 Güte / Grade	N°
500	60 x 30	0,8	0	1682300 78,00 €
750	60 x 30	1,2	0	1682300x 119,00 €
1000	100 x 40	3,0	0	1682301 189,00 €
1500	100 x 40	4,5	1	1682302 320,00 €
2000	100 x 40	6,0	1	1682303 665,00 €
2500	150 x 80	17,5	1	1682304 950,00 €
3000	150 x 80	21,0	2	1682305 1.199,00 €

Parallelunterlagen-Sätze
ULTRA active



- ▶ Werksnorm
- ▶ Spezialstahl gehärtet
- ▶ 4 Längsflächen paarweise planparallel bearbeitet
- ▶ Nennmaßtoleranz der Höhe und Breite $\pm 0,01$ mm
- ▶ durch verschiedene Kombinationen können Nennmaße in 1mm Stufung gebildet werden (ausgenommen Nennmaß 9mm bei Länge 125mm und 150mm)
- ▶ Lieferung im Holzständer stehend

Parallel support sets
ULTRA active

- ▶ Works standard
- ▶ Hardened special steel
- ▶ 4 longitudinal surfaces plane parallel-machined in pairs
- ▶ Nominal size tolerance of height and width ± 0.01 mm
- ▶ Nominal sizes can be attained in 1mm step through several combinations (Excepting 9 mm nominal size in lengths 125 mm and 150 mm)
- ▶ Delivered upright in wooden support

AB LAGER!
EX STOCK!



No. 1568230

Alle Preise abzüglich Rabatt! / Rabatt anfragen
All prices less discount! / Ask for discount

+49 (0) 6021 42999 00

-%

Paare Pair	mm	mm	mm	kg	Nº	
20	2 - 24	2x5/ 2x10/ 2x15/ 2x20/ 3x6/ 3x11/ 3x16/ 3x21/ 4x7/ 4x12 4x17/ 4x22/ 5x8/ 5x13/ 5x18/ 5x23/ 6x9/ 6x14/ 6x19/ 6x24	100	2,4	1568130	266,00 €
24	8 - 42	8x11/ 8x16/ 8x21/ 8x26/ 8x31/ 8x36/ 10x13/ 10x18/ 10x23 10x28/ 10x33/ 10x38/ 12x15/ 12x20/ 12x25/ 12x30 12x35/ 12x40/ 14x17/ 14x22/ 14x27/ 14x32/ 14x37/ 14x42	125	15,5	1568230	304,00 €
24	8 - 42	8x11/ 8x16/ 8x21/ 8x26/ 8x31/ 8x36/ 10x13/ 10x18/ 10x23 10x28/ 10x33/ 10x38/ 12x15/ 12x20/ 12x25/ 12x30/ 12x35 12x40/ 14x17/ 14x22/ 14x27/ 14x32/ 14x37/ 14x42	150	18,5	1568330	347,00 €

Parallelunterlagen-Sätze magnetisch
ULTRA active



- ▶ Werksnorm
- ▶ Spezialstahl gehärtet
- ▶ kratzfest, schwarz eloxiert
- ▶ paarweise geschliffen
- ▶ Nennmaßtoleranz der Höhe und Breite $\pm 0,01$ mm
- ▶ Lieferung im Koffer

Parallel support sets, magnetic
ULTRA active

- ▶ Works standard
- ▶ Hardened special steel
- ▶ Scratch resistant, black anodised
- ▶ Grinded in pairs
- ▶ Nominal size tolerance of height and width ± 0.01 mm
- ▶ Delivered in a case



No. 1570201

NEW Durch die eingelassenen Magneten lässt sich die Spannzeit um bis zu 10 % reduzieren.
The embedded magnets allow the clamping time to be reduced by up to 10 %.



Alle Preise abzüglich Rabatt! / Rabatt anfragen
All prices less discount! / Ask for discount

+49 (0) 6021 42999 00

-%

Paare Pair	mm	mm	mm	kg	Nº	
5	15 - 32	15/22/25/30/32x2,5	120	2,3	1570201	157,00 €
5	15 - 39	15/30/35/37/39x2,5	125	2,3	1570202	172,00 €
5	25 - 47	25/35/40/45/47x2,5	150	2,3	1570203	234,00 €

Anwendungsbeispiel
Example of use

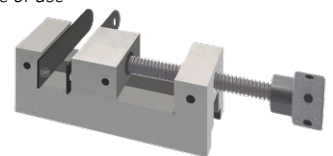

Wussten Sie schon? Did you know?

Bedarf an Spanntechnik?

Wir liefern Magnetspannplatten, Sinustische und Winkelaufspanntische in verschiedenen Ausführungen.

Need for clamping technology?

We deliver magnetic clamping plates, sine tables and angle clamping tables in different executions.



Digital-Neigungsmesser SPI-TRONIC Pro



- ▶ Werksnorm
- ▶ Aluminiumgehäuse
- ▶ großes LCD-Display
- ▶ 1 prismatische Sohle
- ▶ Messbereich 360° (4x90°)
- ▶ Lieferung im Etui

Funktionen:

- ▶ 0-Punkt an jeder Position, HOLD Funktion, RESET und Eigenkalibriermodus

Digital level SPI-TRONIC Pro

- ▶ Works standard
- ▶ Aluminium housing
- ▶ Large LCD display
- ▶ 1 V base
- ▶ Measuring range 360° (4x90°)
- ▶ Delivered in a case

Functions:

- ▶ Zero setting at any position, HOLD function, RESET and self calibration mode



No. 1704101



No. 1704201

L mm	∠	∠	∠	Nº SPI	Nº	Listenpreis Listprice	Aktionspreis Promotion price
150x30x54	0 – 90°	0,1°	0 – 10° / ± 0,1° 10 – 80° / ± 0,2° 80 – 90° / ± 0,1°	PRO360	1704101	648,00 €	632,00 €
150x30x54	0 – 9,99° 10 – 90°	0,01° 0,1°	0 – 10° / ± 0,05° 10 – 80° / ± 0,2° 80 – 90° / ± 0,1°	PRO3600	1704201	1.008,00 €	890,00 €



PROMO
→ 31.12.2025!

Solange der Vorrat reicht!
While stocks last!

% Wichtiger Bestellhinweis % Ihr regulärer Rabatt gilt auch für die bereits reduzierten Aktionspreise!
% Important order notice % Your regular discount also applies to the already reduced promotional prices!

Richtwaagen ULTRA active Horizontalmodell



- ▶ DIN 877
- ▶ Basis aus Spezialguss
- ▶ Handwärmeschutz
- ▶ 1 prismatische Sohle
- ▶ Längs- und Querlibelle
- ▶ Lieferung im Holzetui

Engineer's levels ULTRA active Horizontal model

- ▶ DIN 877
- ▶ Special cast-iron base
- ▶ Insulated pads
- ▶ 1 V base
- ▶ Longitudinal and lateral vials
- ▶ Delivered in wooden box

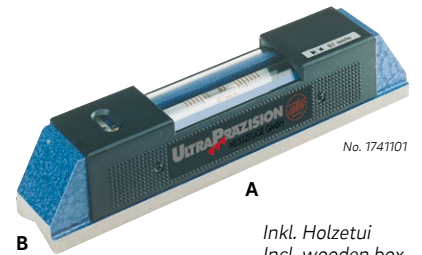

No. 1741101

Inkl. Holzetui
Incl. wooden box



Alle Preise abzüglich Rabatt! / Rabatt anfragen
All prices less discount! / Ask for discount +49 (0) 6021 42999 00 -%

A mm	B mm	kg	∠ ≤ 0,1 mm/m Nº	∠ ≤ 0,02 mm/m Nº
160	42	1,1	1741101	176,00 €
200	42	1,4	1741102	212,00 €
250	42	1,7	1741103	222,00 €
300	51	2,3	1741104	249,00 €
500	51	4,9	1741105	478,00 €

Richtwaagen ULTRA active Winkelmodell



- ▶ DIN 877
- ▶ Rahmen aus Spezialguss
- ▶ Handwärmeschutz
- ▶ 4 Messflächen, 3 mit Prisma
- ▶ Längs- und Querlibelle
- ▶ Lieferung im Holzetui

Engineer's levels ULTRA active Square frame

- ▶ DIN 877
- ▶ Special cast-iron frame
- ▶ Insulated pads
- ▶ 4 measuring faces, 3 with V grooves
- ▶ Longitudinal and lateral vials
- ▶ Delivered in wooden box

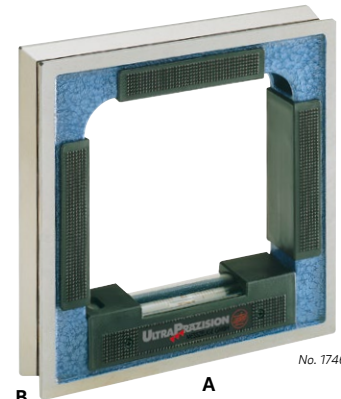

No. 1746102





Inkl. Holzetui
Incl. wooden box

Alle Preise abzüglich Rabatt! / Rabatt anfragen
All prices less discount! / Ask for discount +49 (0) 6021 42999 00 -%































A mm	B mm	kg	∠ ≤ 0,1 mm/m Nº	∠ ≤ 0,02 mm/m Nº
100 x 100	27	0,8	1746101	349,00 €
150 x 150	35	2	1746102	401,00 €
200 x 200	40	3,8	1746103	492,00 €
300 x 300	55	7,9	1746104	804,00 €

WEITERE WAAGEN?
MORE LEVELS?





Siehe Shop! See shop!

Produkttitel		Product title	
			
► Beschreibung		► Description	
1234 1..: Produktvariante		1234 1..: Product version	
1235 1..: Zubehör		1235 1..: Accessories	
 Hinweise		 Note	
 mm	 kg	Nº	Nº
0 – 50	0,04	1234101	1235101
50 – 100	0,08	1234102	1235102
100 – 200	0,20	1234103	1235103

Tabellensymbole Table symbols

Nº	Artikelnummer Article number
	Eigengewicht Own weight
	Genauigkeitsgrad Accuracy grade
	Nennmaß Nominal size
	Stufung Step
	Ablesung Reading
	Mess- / Verstellbereich Measuring / Adjusting range
	Schnabellänge Jaw length
	Brücenlänge Bridge length
	Messtiefe Measuring depth
	Bügeltiefe Frame depth
	Ausladung Throat
	Höhe Height
	Breite / Länge Width / Length
	Größe x/y Dimension x/y
	Größe x/y/z Dimension x/y/z
	Messfläche / Wägeplatte Meas. surface / Weighing plate
	Querschnitt Cross section
	Säulen- / Gehäuse Ø Column / Housing Ø
	Geradheit Straightness
	Winkligkeit Angularity
	Parallelität Parallelism
	Zylinderform Cylindrical form
	Ebenheit Flatness
	Winkel Angle
	Verlängerung Extension
	Skala Scale
	Umdrehung im Uhrzeigersinn Rotation clockwise
	Umdrehung gegen Uhrzeigersinn Rotation anti-clockwise
	Messkraft / Teilgewicht / Nennlast Meas. force / Piece weight / Load
	Haftkraft Adhesive force
	Vergrößerung Magnification

Herkunft unserer Produkte Origin of our products

	Hergestellt in Deutschland. Made in Germany.		Hergestellt in Zentral-Europa. Design und/oder Finish in Deutschland. Made in Central Europe Design and/or finishing in Germany.
	Hergestellt in der Schweiz. Made in Swiss.		Hergestellt außerhalb Europa. Made outside Europe.
	Hergestellt in Zentral-Europa. Made in Central Europe.		Hergestellt außerhalb Europa. Design und/oder Finish in Deutschland. Made outside Europe. Design and/or finishing in Germany.

Produktmerkmale Product features

	Hart / Verschleißfest Hard / wear resistant		Wifi
	Geringes Gewicht / Leichtbauweise Low weight / lightweight construction		USB
	Schutzart IP65 Protection class IP65		RS232
	Schutzart IP67 Protection class IP67		Digimatic
	Sylvac System		Kalibrierschein Calibration certificate
	ABS Funktion ABS function		Kunstledertasche Imitation leather bag
	Bluetooth		Etui Case

www.ultra-germany.shop

Erleben Sie unseren Shop!

- ▶ Hoher Informationsgehalt zu unseren Produkten
- ▶ Schneller Zugriff auf Preise und Lieferzeiten
- ▶ Ständig verfügbar und 24/7 abrufbar
- ▶ Zeitersparnis im Tagesgeschäft

Experience our shop!

- ▶ High informational content about our products
- ▶ Quick access to prices and delivery times
- ▶ Constantly available and accessible 24/7
- ▶ Time saving in daily business

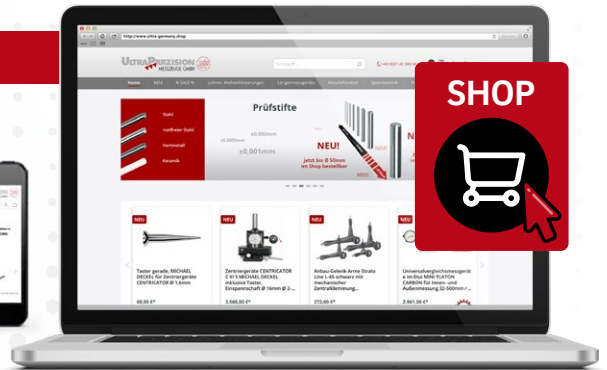
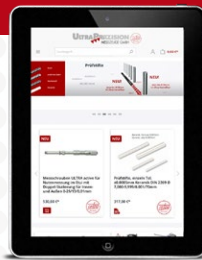

Starke Marken mit klaren Zielen! / Strong brands with clear targets!

Winkelprüfgeräte 90°
Squareness testers 90°



Shop 

Universalvergleichsmessgeräte
Universal comparative measuring instruments



Shop 

Digital-Tiefenmessschieber DIGI RICOR
Digital depth calipers DIGI RICOR



Messeinsätze auswechselbar
Inserts interchangeable

Shop 

SU-Innenfeinmessgeräte
SU precision bore gauges



Shop 

Digital-Dickenmessgeräte
Digital thickness gauges



Shop 

Digital-Schnelltester für Dreipunkt-Messung
Digital dial caliper gauges for 3-point measurement



Shop 

Magnet-Gelenk-Messstative µ-Line
Articulated measuring stands µ-Line



Shop 

LEITECH Gewindelehndorne
LEITECH thread plug gauges



Shop 

Präzisions-Lehrenschaubstöcke
Precision vices



0 - 60°

Shop 

Digital-Höhenmessgeräte
Digital height gauges



Shop 

Monochromatische Lichtquellen
Monochromatic Light Units



Shop 

Digital-Fühlhebelmessgeräte S_Dial TEST Smart
Digital dial test indicators S_Dial TEST Smart



Shop 

ULTRA PRÄZISION MESSZEUGE GMBH
Weitzkaut 3, 63864 Glattbach, Germany

Fon: +49 (0) 60 21 42 999 00
Fax: +49 (0) 60 21 42 999 01
E-Mail: info@ultra-germany.com

HRB: 2801 Aschaffenburg
VAT: DE 132 104 210
TIN: 204/140/70133

DUNS: 319 663 969
ISO: 09-4960637424
GLN: 40 66918 00000 2
WEEE: DE45350537
BattG: DE 34541218



www.ultra-germany.com



www.ultra-germany.shop



@ultra_germany

TRADITION•PRÄZISION•INNOVATION seit 1888

TRADITION•PRECISION•INNOVATION since 1888

